



# Diamond tools and machines for the construction industry

English | 2022

Premium grinding tools since 1919  
[www.tyrolit.com](http://www.tyrolit.com)

**TYROLIT**



# Diamond tools and machines Product catalogue



# The TYROLIT Group

TYROLIT is one of the world's leading manufacturers of grinding and dressing tools as well as a system provider for the construction industry.

Since 1919, our innovative tools have made an important contribution to the technological development in many industries. TYROLIT offers tailored grinding solutions for various applications, as well as a comprehensive assortment of standard tools for customers all over the world.

Headquartered in Schwaz (Austria), the family-owned business combines the strengths of being a part of the dynamic Swarovski Group with a century's worth of individual corporate and technological experience.



TYROLIT headquarters in Schwaz (Austria)

## Facts & Figures



**80,000+**  
products



**29**  
production sites



**4,400+**  
employees worldwide



**36**  
sales locations



**500+**  
worldwide patents

Sales companies in Argentina, Australia, Austria, Belgium, Brazil, Canada, China, Czechia, Denmark, Estonia, Finland, France, Germany, Hungary, India, Indonesia, Italy, the Netherlands, Norway, Poland, Portugal, Russia, South Africa, South Korea, Spain, Sweden, Switzerland, Thailand, the UAE, the UK and the USA. Distributors in 65 other countries.



# Business units

## METAL INDUSTRIES



### Automotive industry

Our leading grinding solutions are used for the production of automotive parts with highest precision.



### Steel & Foundry

With many years of experience in the machining of high alloyed steel we are the market-leader in the steel industry.



### Precision industries

The extensive field of precision industries includes tools and system solutions for various highly specialised applications.



### Industrial trade

Our comprehensive assortment for cutting, grinding and surface treatment for professional end users is available worldwide.

## CONSTRUCTION



### Construction industry

The assortment of high efficiency diamond tools is tailored for the specific needs of customers in the construction industry.



### Trade & Rental

Our wide range of professional system solutions for construction-related applications is available worldwide.



### Construction professionals

We impress users with extensive know-how in the creation of perfectly optimised machines and tools and a fast repair service.



### Project services

Our project services team develops individual system solutions for customer-specific special construction applications.

## Leading through true innovation

A passion for technology, many years of experience and a strong innovative spirit have been incorporated into the manufacture of outstanding grinding solutions.



As one of the first abrasives manufacturers to integrate the new **X-Lock** clamping technology into our assortment of grinding discs, we are at the forefront of the angle grinder landscape. One click and it's done.



**TYROLIT Power** revolutionised the finishing of hard surfaces. Sanding strips consisting of layers made from cactus hair and diamond provide extreme hardness, save time and significantly reduce vibrations for the user.



We took a leap forward in laminated glass grinding with our **REVERSE** wheels, simplifying grinding operations, improving yields and the processing quality while equally reducing stress to the tool and the workpiece.



Our patented **lightweight core technologies** enable us to improve customers' precision grinding processes, saving them time and money. This is possible through computer-calculated targeted material reductions or the use of natural fibres.



With our modular assistance system **ToolScope** we set a milestone for the digitalisation of grinding technology. The system allows customers to utilise existing data and through increased process transparency optimise their whole production chain.

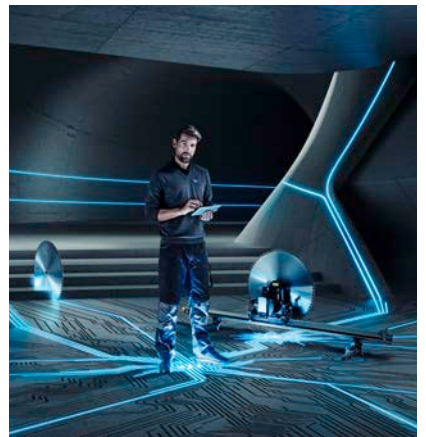

**MoveSmart** is a novel monitoring system for the construction industry, connecting TYROLIT machines to the Internet of Things and processing user data directly on site and in real-time. A smart move into the future.

# International production and sales locations

TYROLIT is represented in 29 countries through its own production and sales companies and cooperates in a further 65 countries with local partners.



Production location in Rayong (Thailand)



The European logistics centre in Benátky (Czechia)

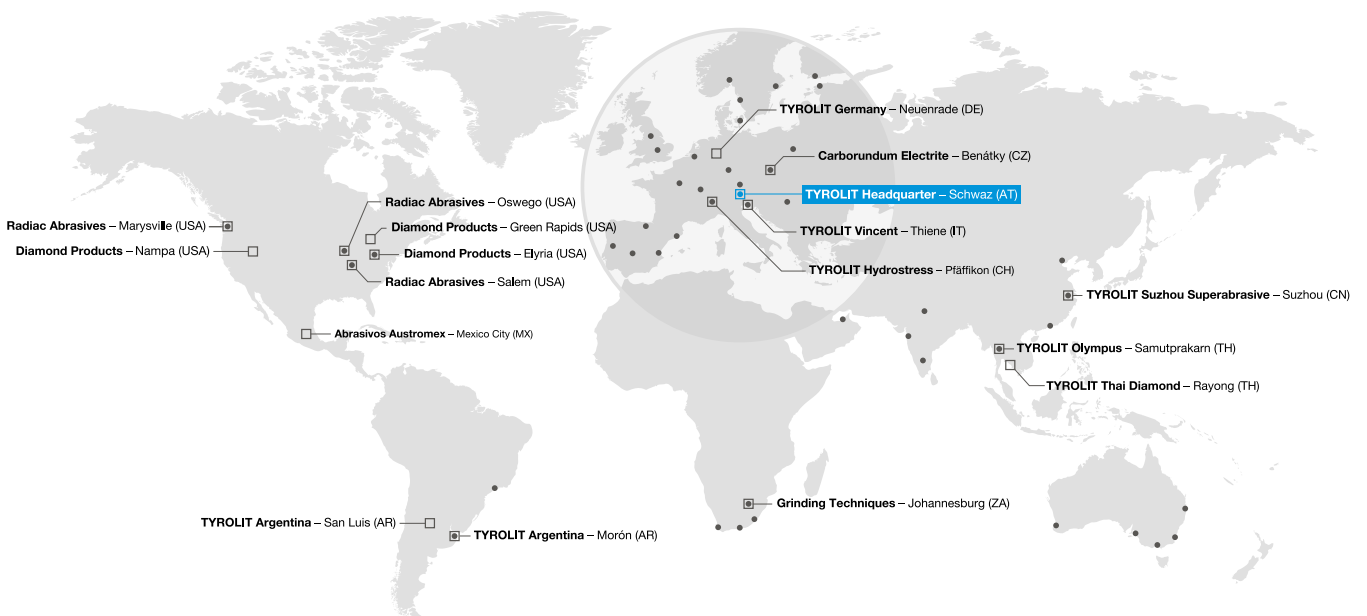

□ TYROLIT production sites  
sites are only named once

● TYROLIT sales locations  
locations are only named once | includes service locations



# Quality lines

TYROLIT has been one of the leading manufacturers of tools for every professional and application for almost 100 years.

To make your search for the ideal tool easier, we have divided our range into three performance levels. This enables us to offer the perfect solution for every application!

<p>★★★ <b>PREMIUM</b></p>	<p>★★ <b>STANDARD</b></p>	<p>★ <b>BASIC</b></p>
<p><b>Maximum performance and highest lifetime for professional use.</b></p>	<p><b>Exceptional working comfort and efficiency for experienced use.</b></p>	<p><b>Quality tools for ideal working results in everyday use.</b></p>





# Specific information

## Diamond tools

### Product label

**NEW**



### Colour codes



**Label**

Universal    Plastic    Concrete    Hard stone    Tiles    Marble    Asphalt    Abrasive materials    Cast iron

**Colour code**



**Material**

Universal building materials    Plastic    Concrete    Hard stone    Tiles, ceramic materials    Soft stone, marble    Abrasive materials    Abrasive materials    Cast iron

# Convincing, technologies



TYROLIT diamond tools with TGD® technology feature intelligently distributed diamonds that enable even load distribution, optimised cooling and a constantly high cutting performance. This significantly extends the tool lifetime and the load on the machines is reduced.

**Your advantages:**

- + Long lifetime
- + High cutting ability
- + Enhanced efficiency

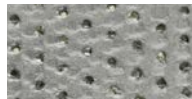

TGD® Segment



Conventional segment



P2® – PERMANENT POWER – is a high-frequency technology registered by TYROLIT, which combines the compact design of electrical systems with the reliability and performance of hydraulic systems in a single machine to optimum effect. This innovative drive concept is based on the principle of drive motors with permanent magnets and enables operation at a high torque, with simultaneously reduced motor speeds. The maintenance-friendly layout of the compact devices makes servicing easier and reduces costs.

**Your advantages:**

- + High reliability
- + Powerful performance
- + Compact design



Thanks to the TYROLIT Modular System, individual components can be used for the same area of application and for different applications. This not only makes the work easier and more efficient, it also saves on costs. One part of the TYROLIT Modular System is the ModulDrill™ quick clamping system, for example, which enables our drill motors to be rapidly attached to different TYROLIT drill rigs.

**Your advantages:**

- + High cost efficiency
- + Efficient working
- + Easy operation



With the MoveSmart Technology, TYROLIT machines are connected to the Internet for the very first time. The technology processes real-time user data directly at the construction site and makes it available on various end-user devices. The cloud-based MoveSmart Technology was developed in collaboration with the Austrian start-up ToolSense and provides users and business owners with important machine and usage data, helping them to get the most out of their equipment. Service hours, error reports and pending software updates, for instance, can be recalled anywhere and at any time. This enables better planning, as well as faster and more cost-efficient operation based on real data.

**Your advantages:**

- + Increased productivity
- + Reduced service times
- + Targeted product development





Products with these technologies are identified by these icons on the following pages.

# TYROLIT Modular System

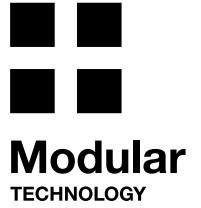

Thanks to the TYROLIT Modular System, individual components can be used for the same area of application and for different applications. This not only makes the work easier and more efficient, it also saves on costs.

One part of the TYROLIT Modular System is the ModulDrill™ quick clamping system, for example, which enables our drill motors to be rapidly attached to different TYROLIT drill rigs.

## Modular components for different applications

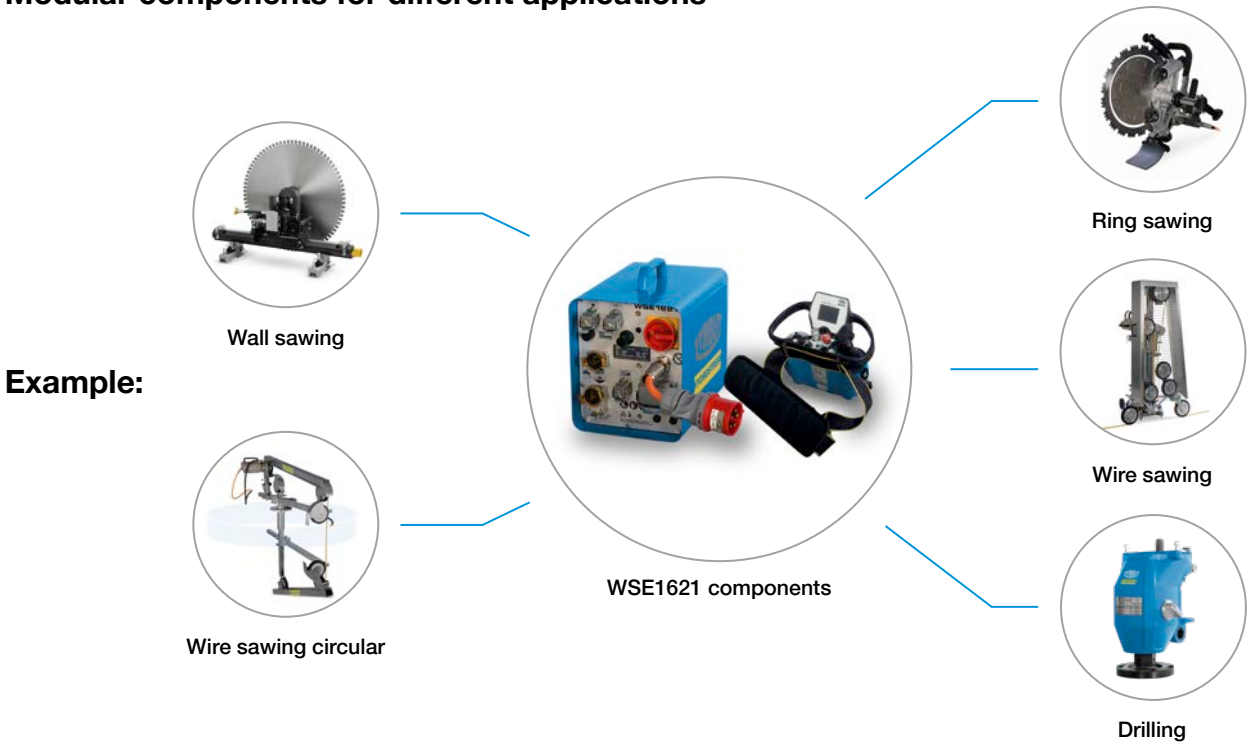

	WSE1217	WSE1621	WSE2226
Wire saw WCU17	•	•	
Wire saw SB-E			•
Wire saw circular CCE25	•	•	
Drilling gearbox DGB1000	•	•	
Ring saw HRE410		•	



**Modular components within the same area of application**

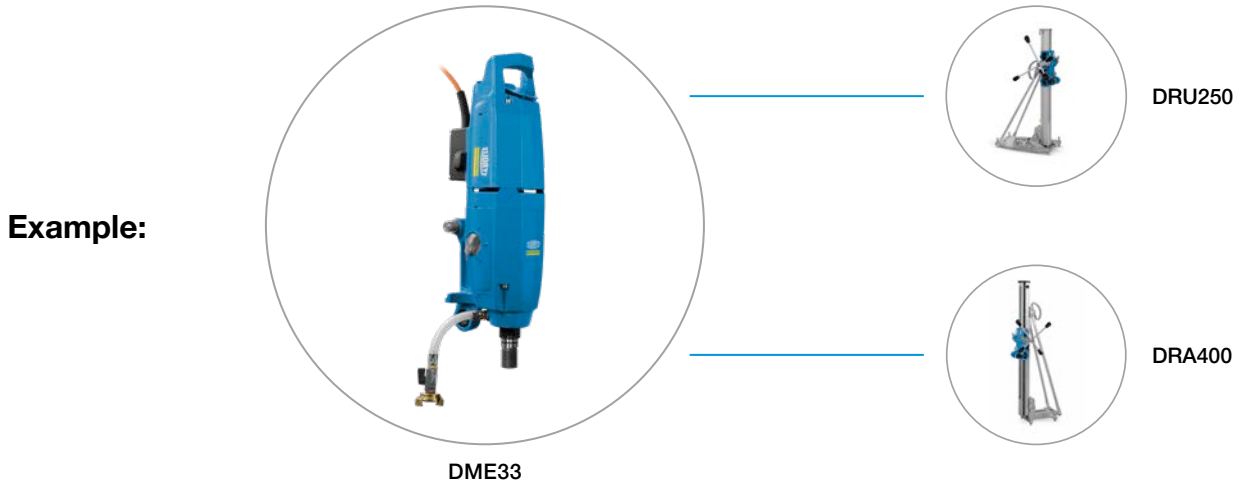

**ModulDrill™ clamping system**

	DME24MW   DME24UW	DME33MW   DME33UW	DGB1000	Hydraulic options
DRA250	●	●		
DRU250	●	●		
DRU350	●	●		
DRA400	●	●		
DRU400	●	●		
DRA500	●	●	●	●
BC-2	●	●	●	●

**Blade guards**

	WSE1621	WSE2226	DZ-S2	WZ	FZ-2ST	FZ-4S
All-in-one blade guard 800	●	●	●	●	●	●
All-in-one blade guard 1000	●	●	●	●	●	●
All-in-one blade guard 1200	●	●	●	●	●	●
Blade guard 1460	●	●		●	●	●
Blade guard 1600	●	●		●	●	●
Blade guard 2200		●				●

**Rail systems**

	WSE1621	WSE2226	DZ-S2	WZ	FZ-2ST	FZ-4S
VAS rail system	●	●	●	●	●	
VS rail system	●	●	●	●	●	●









## Core drilling

---

Information  
Wet drill bits  
Dry drill bits

Tile drills  
Core drill systems

## Wall sawing

---

Information  
Wall saw blades

Machines

## Wire sawing

---

Information  
Diamond saw wires

Accessories  
Machines

## Floor sawing

---

Information  
Floor saw blades

Machines

## Drives

---

Machines

## Free hand

---

Information  
Dry cutting saw blades  
Diamond cup wheels

Hand- and ring saw blades  
Machines

## Table sawing

---

Information  
Table saw blades

Machines

## Other

---

Filter presses  
Pressing and crushing

Notes





# Core drilling

<b>Wet drilling</b>	<b>17</b>
Information	18
Diamond wet drill bits	22
Accessories	33
<b>Dry drilling</b>	<b>35</b>
Information	36
Diamond dry drill bits	40
Accessories	43
<b>Tile drilling</b>	<b>45</b>
Tile drills	46
Tile drill sets	48
<b>Core drill systems</b>	<b>51</b>
Selecting guide for core drill systems	52
Machines	56





# Diamond wet drill bits





## Drill bits for wet drilling

Decades of experience in the production and application of core drill bits and core drill systems give TYROLIT the edge in the marketplace.

As a result, our products can be viewed as innovative solutions for large-scale projects while remaining cost-effective for everyday

construction site use. Especially suitable for drilling reinforced or normal concrete. Can be operated on a drill rig or hand-held. TYROLIT core drill

bits are designed to work perfectly with TYROLIT Hydrostress machines.

### TGD®-Technology

The TYROLIT GRAIN DISTRIBUTION achieves a constant and high cutting performance due to optimum diamond grain distribution.

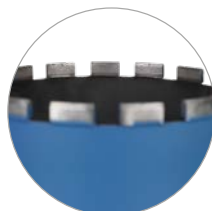

<b>HOHL1</b>	TGD® segments
<b>HOHL1D</b>	Conventional segments with roof shape
<b>HOHL2</b>	Thin-walled wet drill bits with segments set in the carrier
<b>HOHL3</b>	Ring segment - to diameter 42 mm
<b>HOHLT</b>	Diamond dry drill bits



# Speeds

Diameter	Speed	Drive power
Concrete (2-3 m/s)		
mm	rpm	kW
18	2 100-3 200	1
32	1 200-1 800	
42	900-1 400	
52	750-1 100	
62	620-950	2
72	550-800	
82	470-700	
102	370-550	3
122	310-470	
152	250-380	
162	240-350	4
182	210-320	
202	190-280	
250	150-230	
300	130-190	
400	100-140	
500	80-120	

## Service

- + Products for concrete (asphalt, masonry, steel and special applications on request)
- + Mountings and connection threads available to comply with local standards and tailored to suit all types of motors (electric, hydraulic)
- + Perfect system solution in conjunction with TYROLIT Hydrostress drill motors and drill rigs
- + Extensive range of accessories available
- + Special dimensions and individual solutions available on request
- + We will be pleased to provide technical support and system solutions for special construction sites

## Information / Recommendations

- + Highest levels of performance at peripheral speeds of 2-3 m/s on concrete (1.2-1.8 m/s on reinforced concrete, 3.2-3.8 m/s on very abrasive materials)
- + For core drills with a diameter of 400 mm or more, we recommend to use the drill flange GR-F. The core drill program with GR-F flange is available on request (1¼"-4L = the combination GR-F with 1¼" adapter)
- + The correct drill rig mounting is essential
- + The correct coolant quantity is also important for the optimum drilling performance ("milky" consistency of the water)
- + The machine safety and user instructions must be read and understood before starting work. The drilling safety manual will be sent to you on request

# Product life TYROLIT wet drill bits

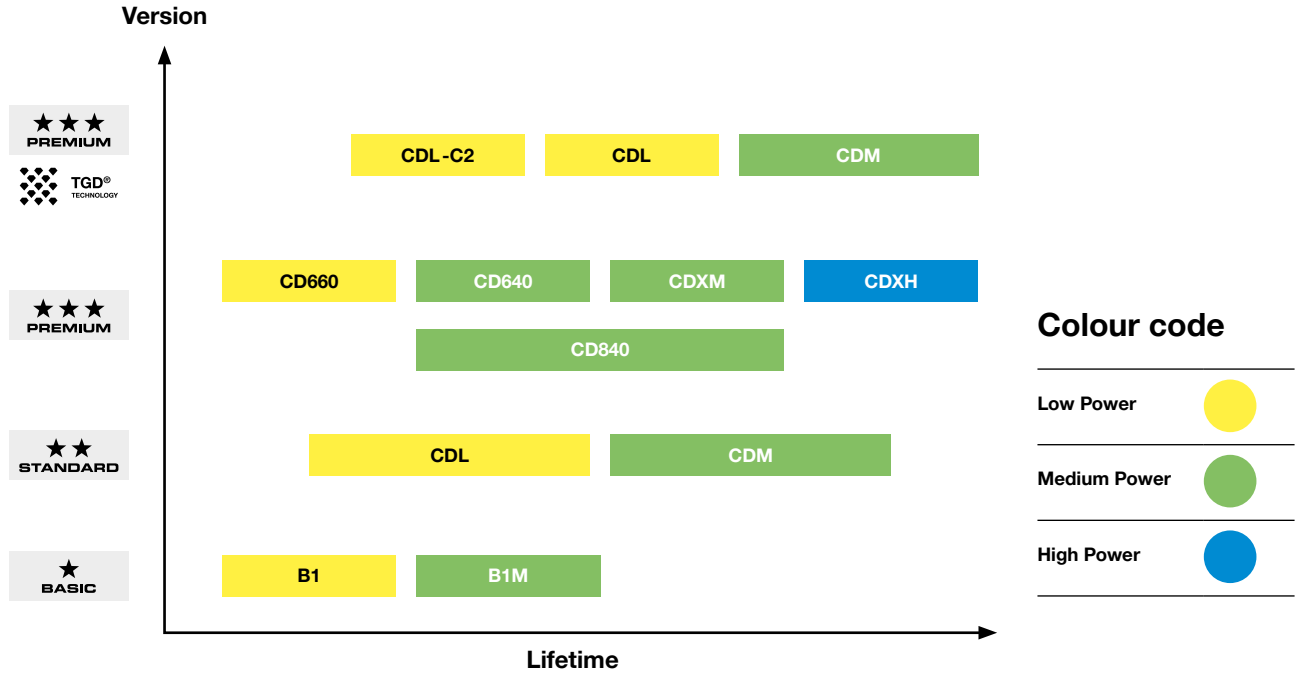

## Segment overview Wet drilling



### TECHNOLOGY

TGD® – optimum diamond grain distribution  
**PREMIUM** CDL, CDM, CDL-C2



### EFFICIENCY

Ideal working results  
**PREMIUM** CDXH, CDXM  
**STANDARD** CDL, CDM  
**BASIC** B1



### CUTTING PERFORMANCE

High cutting ability through U-cuts  
**PREMIUM** CD840, CD640, CD660  
**BASIC** B1M

# Application recommendation

## TYROLIT wet drill bits

### Material properties

Performance Level	Specification	Aggregates				Abrasiveness			Reinforcement		
		soft	medium	hard	very hard	low	medium	high	low	medium	high
★★★ PREMIUM	CDL-C2 TGD®	●	⦿	○		⦿	●	⦿	●	●	⦿
	CDL TGD®	●	●	⦿	○	⦿	●	●	●	●	⦿
	CDM TGD®	⦿	●	●	⦿	○	●	●	⦿	●	●
	CDXH	○	⦿	●	●		○	●	⦿	●	●
	CDXM	⦿	●	●	●	○	⦿	●	⦿	●	●
	CD640	⦿	●	●	●	○	⦿	●	⦿	●	●
	CD660	●	●	⦿	○	⦿	●	⦿	●	⦿	
	CD840	●	●	⦿	○	○	●	●	●	●	⦿
★★ STANDARD	CDL	⦿	⦿	○		○	⦿	⦿	⦿	○	
	CDM	○	⦿	●	●		○	●	⦿	●	●
★ BASIC	B1	●	⦿	⦿		⦿	⦿	○	⦿	○	
	B1M	●	●	⦿		○	●	○	●	●	○
		Limestone Granite	Quartz Granite	Rhine gravel Danube gravel	Flint						

### Machine power

Performance Level	Specification	Machine power			Speed		
		low	medium	high	low	medium	high
★★★ PREMIUM	CDL-C2 TGD®	●	⦿			⦿	●
	CDL TGD®	●	●	○	○	●	●
	CDM TGD®	○	●	●	●	●	⦿
	CDXH	○	⦿	●	⦿	●	○
	CDXM	⦿	●	⦿	○	●	⦿
	CD640	⦿	●	⦿	○	●	⦿
	CD660	●	⦿			⦿	●
	CD840	⦿	●	●	⦿	●	●
★★ STANDARD	CDL	⦿	⦿	○	○	⦿	⦿
	CDM	○	⦿	●	⦿	●	○
★ BASIC	B1	⦿	⦿		○	⦿	⦿
	B1M	○	●	○	○	●	●

#### Suitability

Optimal	●
Good	⦿
Acceptable	○
Not suitable	





## CDL Wet drill bits

for reinforced concrete | in TGD®-Technology (from Ø 47 mm)

- + **Consistently very fast cutting performance and noticeable smooth running** with TGD® Technology (TYROLIT GRAIN DISTRIBUTION), a unique technology developed by TYROLIT for the optimised distribution of grain.



- + **Very long lifetime.**

Drill motors low power | soft to medium-hard concrete aggregates. Quality tools for the most demanding applications and maximum economic

efficiency. Excellent and consistent performance, universal use and smooth core removal. Segment-ed drill from Ø 47 mm with TGD®

Technology and segment height of 11.3 mm. Laser welded segments up to a Ø 300 mm for maximum safety.



### CDL Wet drill bits

for reinforced concrete | in TGD®-Technology (from Ø 47 mm)



	Type no.	Dimension	Segment height
	HOHL3		
	497349	12 × 400 × R½"	7
	854317	14 × 400 × R½"	7
	474990	15 × 400 × R½"	7
	474991	16 × 400 × R½"	7
	474993	18 × 400 × R½"	7
	474995	20 × 400 × R½"	7
	474997	22 × 400 × R½"	7
	475000	24 × 400 × R½"	7
	475009	25 × 400 × R½"	7
	475010	28 × 400 × R½"	7
	475011	30 × 400 × R½"	7
	475012	32 × 400 × R½"	7
	500072	35 × 450 × R½"	7
	475014	37 × 450 × R½"	7
	475015	40 × 450 × R½"	7
475016	42 × 450 × R½"	7	



	Type no.	Dimension	Segment height	
	HOHL1	34178733	47 x 450 x 1¼"	11.3
		34067834	52 x 450 x 1¼"	11.3
		34170724	57 x 450 x 1¼"	11.3
		34159556	62 x 450 x 1¼"	11.3
		34067836	67 x 450 x 1¼"	11.3
		34178734	72 x 450 x 1¼"	11.3
		34017777	82 x 450 x 1¼"	11.3
		34018473	92 x 450 x 1¼"	11.3
		34018475	102 x 450 x 1¼"	11.3
		34018477	107 x 450 x 1¼"	11.3
		34018478	112 x 450 x 1¼"	11.3
		34018480	117 x 450 x 1¼"	11.3
		34018511	122 x 450 x 1¼"	11.3
		34018513	127 x 450 x 1¼"	11.3
		34018514	132 x 450 x 1¼"	11.3
		34018517	142 x 450 x 1¼"	11.3
		34017778	152 x 450 x 1¼"	11.3
		34018520	162 x 450 x 1¼"	11.3
		34018523	172 x 450 x 1¼"	11.3
		34018525	182 x 450 x 1¼"	11.3
		34018528	192 x 450 x 1¼"	11.3
		34017779	202 x 450 x 1¼"	11.3
		34018530	212 x 450 x 1¼"	11.3
		34018533	250 x 450 x 1¼"	11.3
		711267	300 x 450 x 1¼"	11.3
		711268	350 x 450 x 1¼"	11.3
		711269	400 x 450 x 1¼"	11.3
		711270	450 x 450 x 1¼"	11.3
		711272	500 x 450 x 1¼"	11.3
		34072174	52 x 500 x PIXIE	11.3
		34072175	62 x 500 x PIXIE	11.3
		34072176	72 x 500 x PIXIE	11.3
	34018370	82 x 500 x PIXIE	11.3	
	34018474	92 x 500 x PIXIE	11.3	
	34018476	102 x 500 x PIXIE	11.3	
	34018479	112 x 500 x PIXIE	11.3	
	34018512	122 x 500 x PIXIE	11.3	
	34018515	132 x 500 x PIXIE	11.3	
	34018516	138 x 500 x PIXIE	11.3	
	34018518	142 x 500 x PIXIE	11.3	
	34018519	152 x 500 x PIXIE	11.3	
	34018521	162 x 500 x PIXIE	11.3	
	34018524	172 x 500 x PIXIE	11.3	
	34018526	182 x 500 x PIXIE	11.3	
	34018527	186 x 500 x PIXIE	11.3	
	34018529	202 x 500 x PIXIE	11.3	
	34018531	226 x 500 x PIXIE	11.3	
	34018534	250 x 500 x PIXIE	11.3	

For core drills with a diameter of 450 mm or more, we recommend to use the drill flange GR-F. The core drill program with GR-F flange is available on request.



### CDL-C2 Wet drill bits

for reinforced concrete | in TGD®-Technology (from Ø 82 mm)



Drill motors low power | soft to medium-hard concrete aggregates. Quality tools for the most demanding applications and maximum economic efficiency. Excellent and consistent performance, universal use and smooth

core removal. Segmented drill from Ø 82 mm with TGD®-Technology and segment height of 11.3 mm. Laser welded segments up to a Ø 300 mm for maximum safety.

	Type no.	Dimension	Segment height
	HOHL1		
	34018536	82 × 500 × PIXIE	11.3
	34018538	92 × 500 × PIXIE	11.3
	34018539	102 × 500 × PIXIE	11.3
	34018542	107 × 500 × PIXIE	11.3
	34018543	112 × 500 × PIXIE	11.3
	34018544	122 × 500 × PIXIE	11.3
	34018546	127 × 500 × PIXIE	11.3
	34018547	132 × 500 × PIXIE	11.3
	34018549	138 × 500 × PIXIE	11.3
	34018550	142 × 500 × PIXIE	11.3
	34018551	152 × 500 × PIXIE	11.3
	34018553	162 × 500 × PIXIE	11.3
	34018554	172 × 500 × PIXIE	11.3
	34018555	182 × 500 × PIXIE	11.3
	34018556	186 × 500 × PIXIE	11.3
	34018557	202 × 500 × PIXIE	11.3
	34018559	226 × 500 × PIXIE	11.3
	34018560	250 × 500 × PIXIE	11.3
	34018537	82 × 450 × 1¼"	11.3
	34018540	102 × 450 × 1¼"	11.3
	34018545	122 × 450 × 1¼"	11.3
	34018548	132 × 450 × 1¼"	11.3
	34018552	152 × 450 × 1¼"	11.3
	34018558	202 × 450 × 1¼"	11.3
	34018561	250 × 450 × 1¼"	11.3



### CDM Wet drill bits

for reinforced concrete | in TGD®-Technology (from Ø 82 mm)



Drill motors medium power | medium-hard to hard concrete aggregates. Quality tools for the most demanding applications and maximum economic efficiency. Excellent and consistent performance, universal use and smooth

core removal. Segmented drill from Ø 82 mm with TGD®-Technology and segment height of 11.3 mm. Laser welded segments up to a Ø 300 mm for maximum safety.

	Type no.	Dimension	Segment height
	HOHL1D		
	606482	47 × 450 × 1¼"	8.5
	606527	52 × 450 × 1¼"	8.5
	606530	57 × 450 × 1¼"	8.5
	606485	62 × 450 × 1¼"	8.5
	606536	67 × 450 × 1¼"	8.5
606541	72 × 450 × 1¼"	8.5	

● = low

● = medium







		Type no.	Dimension	Segment height
	HOHL1	34223152	77 × 450 × 1¼"	11.3
		34018562	82 × 450 × 1¼"	11.3
		34018564	92 × 450 × 1¼"	11.3
		34018566	102 × 450 × 1¼"	11.3
		34018568	107 × 450 × 1¼"	11.3
		34018569	112 × 450 × 1¼"	11.3
		34018571	117 × 450 × 1¼"	11.3
		34018572	122 × 450 × 1¼"	11.3
		34018574	125 × 450 × 1¼"	11.3
		34018575	127 × 450 × 1¼"	11.3
		34018576	132 × 450 × 1¼"	11.3
		34018579	142 × 450 × 1¼"	11.3
		34018584	152 × 450 × 1¼"	11.3
		34018587	162 × 450 × 1¼"	11.3
		34018589	172 × 450 × 1¼"	11.3
		34018601	182 × 450 × 1¼"	11.3
		34018604	192 × 450 × 1¼"	11.3
		34018605	202 × 450 × 1¼"	11.3
		34018607	212 × 450 × 1¼"	11.3
		34018608	225 × 450 × 1¼"	11.3
34018610	250 × 450 × 1¼"	11.3		
		711343	300 × 450 × 1¼"	11.3
		711344	350 × 450 × 1¼"	11.3
		711347	400 × 450 × 1¼"	11.3
		711348	450 × 450 × 1¼"	11.3
		711349	500 × 450 × 1¼"	11.3



### CDXH Wet drill bits for reinforced concrete



Drill motors high power | hard to very hard concrete aggregate. Quality tools for the most demanding applications and maximum cost efficiency. Universal use and smooth core removal.

Segment height of 11.3 mm for a long lifetime. Laser-welded segments up to Ø 300 mm for maximum safety.

	Type no.	Dimension	Segment height	
	HOHL1D	34196019	52 × 450 × 1¼"	11.3
		34196061	57 × 450 × 1¼"	11.3
		34196063	62 × 450 × 1¼"	11.3
		34196069	72 × 450 × 1¼"	11.3
		34167000	82 × 450 × 1¼"	11.3
		34167261	92 × 450 × 1¼"	11.3
		34167263	102 × 450 × 1¼"	11.3
		34167267	112 × 450 × 1¼"	11.3
		34167281	122 × 450 × 1¼"	11.3
		34167283	127 × 450 × 1¼"	11.3
		34167287	132 × 450 × 1¼"	11.3
		34167292	152 × 450 × 1¼"	11.3
		34167294	158 × 450 × 1¼"	11.3
		34167296	162 × 450 × 1¼"	11.3
		34167302	182 × 450 × 1¼"	11.3
		34167311	202 × 450 × 1¼"	11.3
	34167319	250 × 450 × 1¼"	11.3	
	34196074	300 × 450 × 1¼"	11.3	



### CDXM Wet drill bits for reinforced concrete



Drill motors medium power | medium-hard to very hard concrete aggregate. Quality tools for the most demanding applications and maximum cost efficiency. Universal use and smooth core removal.

Segment height of 11.3 mm for a long lifetime. Laser-welded segments up to Ø 300 mm for maximum safety. Pre-drilling segments on request. With segment widths up to 7.5 mm.

	Type no.	Dimension	Segment height	
	HOHL1D	34331923	47 × 450 × 1¼"	11.3
		34206525	52 × 450 × 1¼"	11.3
		34331924	57 × 450 × 1¼"	11.3
		34206526	62 × 450 × 1¼"	11.3
		34206527	67 × 450 × 1¼"	11.3
		34206528	72 × 450 × 1¼"	11.3
		34206529	77 × 450 × 1¼"	11.3
		34167814	82 × 450 × 1¼"	11.3
		34167816	87 × 450 × 1¼"	11.3
		34167819	92 × 450 × 1¼"	11.3
		34409913	96 × 450 × 1¼"	11.3
		34167831	102 × 450 × 1¼"	11.3



		Type no.	Dimension	Segment height
	HOHL1D	34167833	107 × 450 × 1¼"	11.3
		34167835	112 × 450 × 1¼"	11.3
		34167837	117 × 450 × 1¼"	11.3
		34167839	122 × 450 × 1¼"	11.3
		34167841	127 × 450 × 1¼"	11.3
		34167843	132 × 450 × 1¼"	11.3
		34167845	142 × 450 × 1¼"	11.3
		34167847	152 × 450 × 1¼"	11.3
		34167849	158 × 450 × 1¼"	11.3
		34167851	162 × 450 × 1¼"	11.3
		34167853	167 × 450 × 1¼"	11.3
		34167855	172 × 450 × 1¼"	11.3
		34167857	182 × 450 × 1¼"	11.3
		34167859	187 × 450 × 1¼"	11.3
		34167861	192 × 450 × 1¼"	11.3
		34167863	202 × 450 × 1¼"	11.3
		34167865	212 × 450 × 1¼"	11.3
		34167867	225 × 450 × 1¼"	11.3
34167869	240 × 450 × 1¼"	11.3		
34167873	250 × 450 × 1¼"	11.3		



### CD840 Wet drill bits for reinforced concrete



Drill motors medium power | soft to medium-hard concrete aggregate.  
Quality tools for the most demanding applications and maximum cost efficiency. Universal use and smooth core removal.

Segment height of 11.3 mm for a long lifetime, segment geometry for a high stock removal rate. Laser-welded segments up to Ø 300 mm for maximum safety.

		Type no.	Dimension	Segment height
	HOHL1D	34235150	82 × 450 × 1¼"	11.3
		34235193	92 × 450 × 1¼"	11.3
		34233042	102 × 450 × 1¼"	11.3
		34235146	107 × 450 × 1¼"	11.3
		34239079	112 × 450 × 1¼"	11.3
		34235690	117 × 450 × 1¼"	11.3
		34239092	122 × 450 × 1¼"	11.3
		34235147	127 × 450 × 1¼"	11.3
		34235149	132 × 450 × 1¼"	11.3
		34239094	142 × 450 × 1¼"	11.3
		34233043	152 × 450 × 1¼"	11.3
		34239095	162 × 450 × 1¼"	11.3
		34239096	172 × 450 × 1¼"	11.3
		34239097	182 × 450 × 1¼"	11.3
		34233045	202 × 450 × 1¼"	11.3
		34239999	212 × 450 × 1¼"	11.3

● = medium



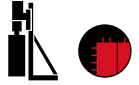

**CD840 Wet drill bits**  
for reinforced concrete

HOHL1D

Type no.	Dimension	Segment height
34240000	250 × 450 × 1¼"	11.3
34240001	300 × 450 × 1¼"	11.3
34240003	350 × 450 × 1¼"	11.3
34240004	400 × 450 × 1¼"	11.3
34240005	450 × 450 × 1¼"	11.3
34240006	500 × 450 × 1¼"	11.3

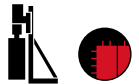
**CD640 Wet drill bits**  
for reinforced concrete

HOHL1D

Type no.	Dimension	Segment height
34239204	47 × 450 × 1¼"	11.3
34235195	52 × 450 × 1¼"	11.3
34239032	57 × 450 × 1¼"	11.3
34239056	62 × 450 × 1¼"	11.3
34235196	67 × 450 × 1¼"	11.3
34239057	72 × 450 × 1¼"	11.3
34239058	82 × 450 × 1¼"	11.3
34239059	92 × 450 × 1¼"	11.3
34233006	102 × 450 × 1¼"	11.3
34239060	107 × 450 × 1¼"	11.3
34239071	112 × 450 × 1¼"	11.3
34239072	122 × 450 × 1¼"	11.3
34447504	125 × 450 × 1¼"	11.3
34239073	127 × 450 × 1¼"	11.3
34239074	132 × 450 × 1¼"	11.3
34239075	142 × 450 × 1¼"	11.3
34233007	152 × 450 × 1¼"	11.3
34239076	162 × 450 × 1¼"	11.3
34239077	172 × 450 × 1¼"	11.3
34239078	182 × 450 × 1¼"	11.3
34233008	202 × 450 × 1¼"	11.3
34239991	212 × 450 × 1¼"	11.3
34297991	225 × 450 × 1¼"	11.3
34239992	250 × 450 × 1¼"	11.3
34239993	300 × 450 × 1¼"	11.3
34239994	350 × 450 × 1¼"	11.3

Drill motors medium power | medium-hard to very hard concrete aggregate. Quality tools for the most demanding applications and maximum cost efficiency. Universal use and smooth core removal.

Segment height of 11.3 mm for a long lifetime, segment geometry for a high stock removal rate. Laser-welded segments up to Ø 300 mm for maximum safety.





		Type no.	Dimension	Segment height
	HOHL1D	34239995	400 × 450 × 1¼"	11.3
		34239996	450 × 450 × 1¼"	11.3
		34239997	500 × 450 × 1¼"	11.3
		34471403	600 × 450 × 1¼"	11.3



### CD660 Wet drill bits for reinforced concrete



Drill motors low power | soft concrete aggregate | high speed. Quality tools for the most demanding applications and maximum cost efficiency. Universal use and smooth core removal.

Segment height of 11.3 mm for a long lifetime, segment geometry for a high stock removal rate. Laser welded segments up to Ø 300 mm for maximum safety.

		Type no.	Dimension	Segment height
	HOHL1D	34239202	47 × 450 × 1¼"	11.3
		34238995	52 × 450 × 1¼"	11.3
		34238996	57 × 450 × 1¼"	11.3
		34238997	62 × 450 × 1¼"	11.3
		34238998	67 × 450 × 1¼"	11.3
		34238999	72 × 450 × 1¼"	11.3
		34239203	75 × 450 × 1¼"	11.3
		34239000	82 × 450 × 1¼"	11.3
		34239011	92 × 450 × 1¼"	11.3
		34233009	102 × 450 × 1¼"	11.3
		34239012	107 × 450 × 1¼"	11.3
		34239013	112 × 450 × 1¼"	11.3
		34239015	122 × 450 × 1¼"	11.3
		34239017	127 × 450 × 1¼"	11.3
		34239021	132 × 450 × 1¼"	11.3
		34239023	142 × 450 × 1¼"	11.3
		34233010	152 × 450 × 1¼"	11.3
		34239027	162 × 450 × 1¼"	11.3
		34239029	172 × 450 × 1¼"	11.3
		34239030	182 × 450 × 1¼"	11.3
		34233012	202 × 450 × 1¼"	11.3
		34239984	212 × 450 × 1¼"	11.3
		34239985	250 × 450 × 1¼"	11.3
34239986	300 × 450 × 1¼"	11.3		
34239987	350 × 450 × 1¼"	11.3		
34239988	400 × 450 × 1¼"	11.3		
34239989	450 × 450 × 1¼"	11.3		
34239990	500 × 450 × 1¼"	11.3		



### CDL Wet drill bits for reinforced concrete



Drill motors low power | soft to medium-hard concrete aggregates.  
Details: Quality tools for everyday use. An impressive drilling speed-lifetime ratio. Universal use, lasting quality.

Laser welded segments up to a diameter of 300 mm for maximum safety.

	Type no.	Dimension	Segment height	
	HOHL3	475019	32 × 400 × R½"	
		475024	42 × 450 × R½"	
	HOHL1D	34292638	52 × 450 × 1¼"	11.3
		34292640	62 × 450 × 1¼"	11.3
		34292816	72 × 450 × 1¼"	11.3
		34292820	82 × 450 × 1¼"	11.3
		34292821	92 × 450 × 1¼"	11.3
		34292823	102 × 450 × 1¼"	11.3
		34292824	107 × 450 × 1¼"	11.3
		34292826	112 × 450 × 1¼"	11.3
		34292827	122 × 450 × 1¼"	11.3
		34292828	127 × 450 × 1¼"	11.3
		34292829	132 × 450 × 1¼"	11.3
		34292830	142 × 450 × 1¼"	11.3
		34292831	152 × 450 × 1¼"	11.3
		34292832	162 × 450 × 1¼"	11.3
		34292833	182 × 450 × 1¼"	11.3
		34292834	202 × 450 × 1¼"	11.3
		34292835	250 × 450 × 1¼"	11.3



### CDM Wet drill bits for reinforced concrete



Drill motors medium power | medium-hard to hard concrete aggregates.  
Details: Quality tools for everyday use. an impressive drilling speed-lifetime ratio. Universal use, lasting quality.

Laser welded segments up to a diameter of 300 mm for maximum safety.

	Type no.	Dimension	Segment height
	HOHL1D	34293083	52 × 450 × 1¼"
		34293087	62 × 450 × 1¼"
		34293089	72 × 450 × 1¼"
		34293111	82 × 450 × 1¼"
		34293115	92 × 450 × 1¼"
		34293116	102 × 450 × 1¼"
		34293120	107 × 450 × 1¼"
		34293122	112 × 450 × 1¼"
		34293124	122 × 450 × 1¼"

● = low

● = medium







		Type no.	Dimension	Segment height
	HOHL1D	34293125	127 × 450 × 1¼"	11.3
		34293129	132 × 450 × 1¼"	11.3
		34293130	142 × 450 × 1¼"	11.3
		34293132	152 × 450 × 1¼"	11.3
		34293137	162 × 450 × 1¼"	11.3
		34293139	182 × 450 × 1¼"	11.3
		34293140	202 × 450 × 1¼"	11.3
		34293149	250 × 450 × 1¼"	11.3
		34334960	300 × 450 × 1¼"	11.3



### B1 Wet drill bits for reinforced concrete



Drill motors low power | soft concrete aggregate. Quality tools for everyday use. Segment height of 11.3 mm for improved lifetime. Laser welded segments up to Ø 300 mm for maximum safety.

		Type no.	Dimension	Segment height
	HOHL1D	34239241	47 × 450 × 1¼"	11.3
		34239244	52 × 450 × 1¼"	11.3
		34239245	57 × 450 × 1¼"	11.3
		34206245	62 × 450 × 1¼"	11.3
		34206246	67 × 450 × 1¼"	11.3
		34239181	72 × 450 × 1¼"	11.3
		34206248	77 × 450 × 1¼"	11.3
		34206249	82 × 450 × 1¼"	11.3
		34239183	92 × 450 × 1¼"	11.3
		34203877	102 × 450 × 1¼"	11.3
		34206261	107 × 450 × 1¼"	11.3
		34206262	112 × 450 × 1¼"	11.3
		34206263	122 × 450 × 1¼"	11.3
		34239093	127 × 450 × 1¼"	11.3
		34206265	132 × 450 × 1¼"	11.3
		34239186	142 × 450 × 1¼"	11.3
		34239187	152 × 450 × 1¼"	11.3
		34206267	162 × 450 × 1¼"	11.3
		34239188	172 × 450 × 1¼"	11.3
		34206269	182 × 450 × 1¼"	11.3
		34239189	202 × 450 × 1¼"	11.3
		34240086	212 × 450 × 1¼"	11.3
		34240087	250 × 450 × 1¼"	11.3



## Accessories wet drill bits

### Adapter



		Type no.	Machine connection	Tool connection
	ADAPT	374035	1 1/4" Female	R 1/2" Female
		381983	R 1/2" Male	1 1/4" Male
		462700	HT 1.5 Female	1 1/4" Male
		681095	HT 2 Female	1 1/4" Male
		759007	R 1/2" Male	10
		909220	1 1/4" Female	3-LOCH

## Accessories wet drill bits

### Sharpening plates



		Type no.	Dimension
	SP1	497322	55 x 25 x 320
		484627	160 x 30 x 320
		484672	320 x 55 x 320

## Accessories wet drill bits

### Carrying handle



	Type no.	Connection
	34277925	1/2" / 1 1/4"

## Accessories wet drill bits

### Brazing magnets

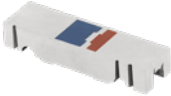

	Type no.	Dimension	Description
	HMAG	529455	0.75 mm until Ø 300 mm 1.00 mm from Ø 300 mm
		529456	0.50 for thin walled carrier HOHL2 1.25 for segments > 5.5 mm



## Accessories wet drill bits

### Extensions



		Type no.	Length	Connection
	HVERL	378198	100	1¼"
		359471	200	1¼"
		359472	300	1¼"
		359473	400	1¼"
		359474	500	1¼"
		400439	100	R½"
		359475	200	R½"
		359476	300	R½"
		889232	400	R½"
		707230	500	R½"

## Accessories wet drill bits

### Water liners



		Type number	Connection	Tool connection
	WSPB	478074	SW12	R½"

# Diamond dry drill bits

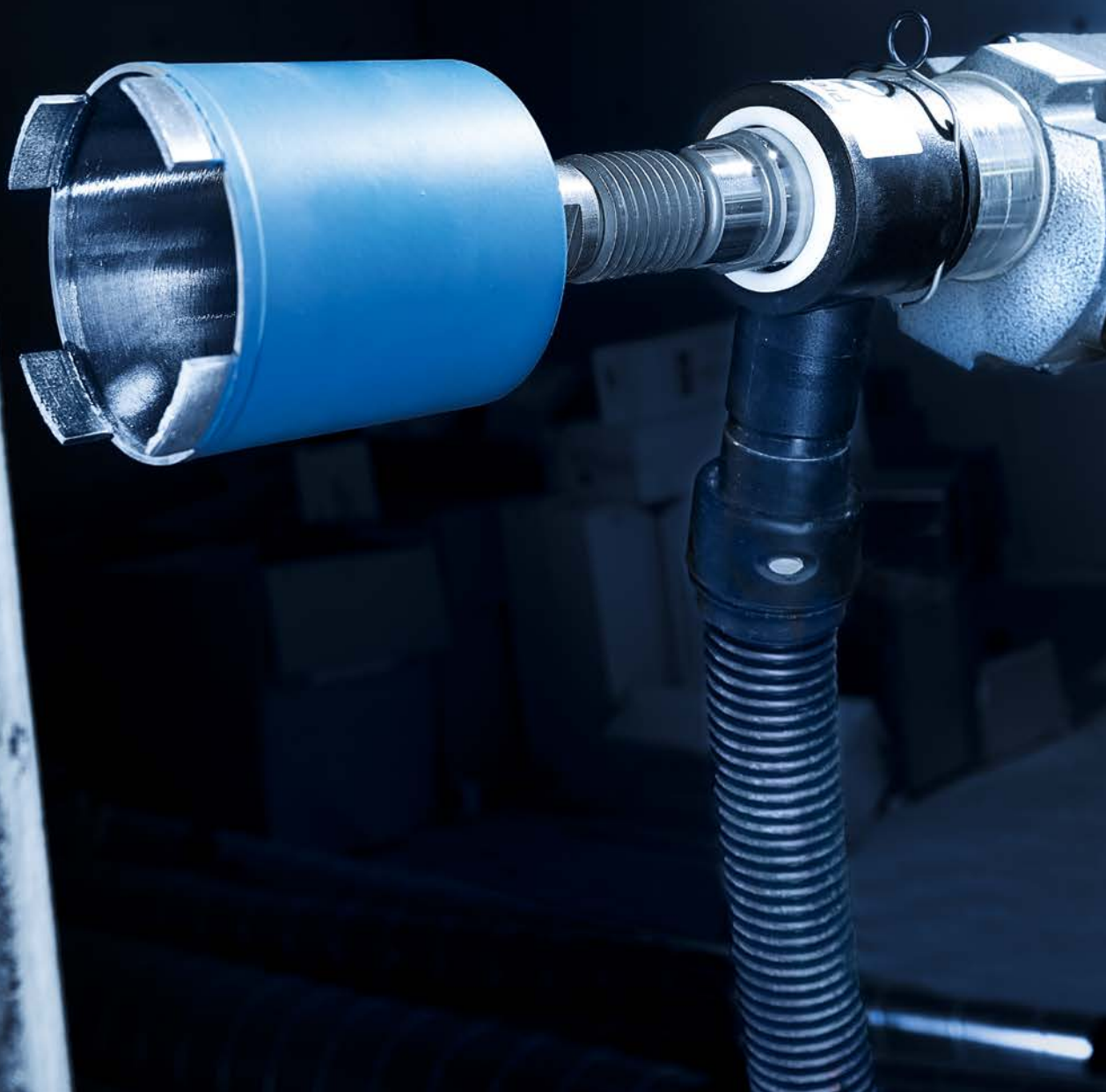



## Drill bits for dry drilling

Decades of experience in the production and application of core drill bits and core drill systems give TYROLIT the edge in the marketplace.

As a result, our products can be viewed as innovative solutions for large-scale projects while remaining cost-effective for everyday

construction site use. Especially suitable for drilling reinforced or normal concrete. Can be operated on a drill rig or hand-held.

TYROLIT core drill bits are designed to work perfectly with TYROLIT Hydrostress machines.



## Selecting the right dry drill bit

Diameter	≤ 82 mm	≥ 91 mm
approx. rpm [rpm]	2000 - 3000	1000 - 1500
Porous concrete (aerated concrete) Plastic piping (PVC, PP, PE) Lightweight refractory bricks Sandstone, porous natural stone Tiles Roofing tiles Clinkers Fine stoneware	without impact drilling	
Soft sand-lime blocks Bricks Lightweight concrete blocks Woodchip slabs and blocks Concrete blocks	Impact drilling recommended (no hammer drills!)	
Hard sand-lime blocks Terrazzo Concrete Lightly reinforced concrete Beton leicht armiert	Impact drilling necessary (no hammer drills!)	

### Service

- + From a diameter of 82 mm onwards an additional distance washer is included for optional use of a vacuum-suction hood

### Information / Recommendations

- + For use with drilling motors within the range of 1 000–2 000 W with or without soft impact
- + Do not use rotary percussion drills as it will destroy the tool
- + Observe the safety and user instructions shipped with the tool
- + On request these safety instructions may also be sent separately

## Dry drilling with compact universal dust extraction system

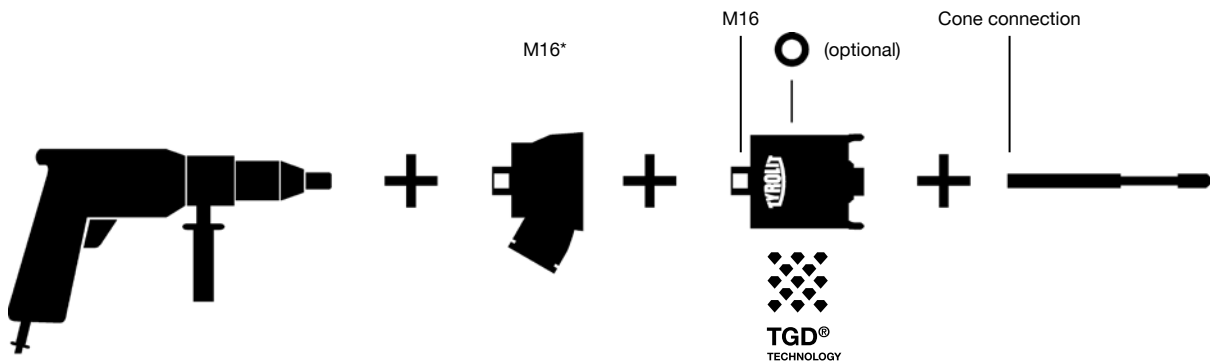

\*Adapter suitable for all common machines (5/8", HEX SW12, SDS, M18) see page 119.

## Dry drilling in reinforced concrete

When it comes to dry drilling, the TYROLIT experts know what counts. And our expertise from special projects, such as the safe decommissioning of nuclear power stations, is put to use in the development of our dry drilling product range. The TYROLIT dry drilling system is the first commercial system on the market that ensures easy and cost-efficient drilling in reinforced concrete.

### One of a kind

- + Easy operation
- + Clean working without a compressor
- + Inexpensive
- + Excellent results in reinforced concrete

### TYROLIT dry drill bits in TGD® Technology

- + Durable, laser-welded segments
- + Ideal for drilling reinforced concrete
- + Large choice of usable lengths and diameters
- + Short lengths for hand-guided drilling

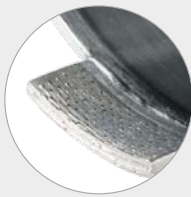

TGD® dry drill bits reliably drill reinforced concrete without deformation.



### Drill motor DME19DP

- + Switchable soft impact function and 1 ¼" and ½" attachments
- + Soft start system and LED monitoring display for optimum drilling speed
- + Centring aid for precise drill bit guidance



# System & Accessories

## System & Accessories

<b>Drill motor DME19DP</b>	
10988200	Drill motor DME19DP (230V)
10990100	Drill rig DRU160 dry
10995437	Drill bit centring for DRU160
10995156	Dust extraction connection 1/2"
10995087	ModulDrill™ clamping collar adapter plate

## Accessories

10995373	Centring spike 450 mm
10997916	Centring spike 250 mm
10995661	Centring blade Ø 52 mm
10995662	Centring blade Ø 62 mm
10995663	Centring blade Ø 68 mm
10995664	Centring blade Ø 72 mm
10995665	Centring blade Ø 82 mm
10995666	Centring blade Ø 92 mm
10995667	Centring blade Ø 102 mm
10995668	Centring blade Ø 112 mm
10995669	Centring blade Ø 122 mm
10995670	Centring blade Ø 127 mm
10995671	Centring blade Ø 132 mm
10995672	Centring blade Ø 142 mm
10995673	Centring blade Ø 152 mm
10995674	Centring blade Ø 162 mm
961955	Adapter 1/2" > M16
10994032	Adapter 1 1/4" > M16
10983964	Dust extraction adapter M16
10983845	Centring spike 140 mm
10986189	Centring spike 233 mm
10986190	Strap wrench
497322	Sharpening plate
980304	Chisel 300 × 25 mm
34215616	Abrasive grain for dry drilling
11002426	Dry vacuum cleaner BBS 606 L (230 V)

## Accessories

976014	Vacuum set
10999500	VPE600 Vacuum pump 230V EU/CH
975381	Vacuum hose 3 m complete



## DDL-RM Dry drill bits

for reinforced concrete | in TGD®-Technology

- + **Consistently very fast cutting performance and noticeable smooth running** with TGD® Technology (TYROLIT GRAIN DISTRIBUTION), a unique technology developed by TYROLIT for the optimised distribution of grain.



- + **Very long lifetime.**

In conjunction with the DME19DP drill motor, the dry drill bits in TGD®-Technology are the perfect solution

for rig-guided dry drilling applications in reinforced concrete.



### DDL-RM Dry drill bits for reinforced concrete | in TGD®-Technology



	Type no.	Dimension	Segment height	
	HOHLT	34227784	47 × 450 × 1¼"	11.3
		34203041	52 × 450 × 1¼"	11.3
		34203212	57 × 450 × 1¼"	11.3
		34220540	62 × 450 × 1¼"	11.3
		34252978	72 × 450 × 1¼"	11.3
		34210273	82 × 450 × 1¼"	11.3
		34290041	92 × 450 × 1¼"	11.3
		34203220	102 × 450 × 1¼"	11.3
		34279921	107 × 450 × 1¼"	11.3
		34267610	112 × 450 × 1¼"	11.3
		34220543	122 × 450 × 1¼"	11.3
		34227727	132 × 450 × 1¼"	11.3
		34227728*	142 × 450 × 1¼"	11.3
		34227729*	152 × 450 × 1¼"	11.3
		34227730*	162 × 450 × 1¼"	11.3

DDL-RM larger than Ø 162 mm on request

\*reinforced concrete is conditionally recommended





### DDL-HH Dry drill bits for lightly reinforced concrete & masonry | in TGD®-Technology



The PREMIUM dry drill bit for hand-guided drilling impresses in many respects. Now available with an extended length of 280 mm as well as with improved segments for the highest safety requirements.

With TGD®-Technology (TYROLIT GRAIN DISTRIBUTION), a unique technology developed by TYROLIT for the optimised distribution of grain.

	Type no.	Dimension	Segment height	
	HOHLT	34482398	52 x 280 x 1¼"	8.5
		34482399	62 x 280 x 1¼"	8.5
		34482400	68 x 280 x 1¼"	8.5
		34482411	72 x 280 x 1¼"	8.5
		34482412	82 x 280 x 1¼"	8.5
		34482413	92 x 280 x 1¼"	8.5
		34482414	102 x 280 x 1¼"	8.5
		34482415	107 x 280 x 1¼"	8.5
		34482416	112 x 280 x 1¼"	8.5
		34482417	122 x 280 x 1¼"	8.5
		34482418	127 x 280 x 1¼"	8.5
		34482419	132 x 280 x 1¼"	8.5
		34482420	138 x 280 x 1¼"	8.5
		34482431	142 x 280 x 1¼"	8.5
		34482433	152 x 280 x 1¼"	8.5
		34482438	161 x 280 x 1¼"	8.5
		34482439	172 x 280 x 1¼"	8.5
		34482440	182 x 280 x 1¼"	8.5
		34482441	187 x 280 x 1¼"	8.5
		34482442	202 x 280 x 1¼"	8.5



### DDL Dry drill bits for lightly reinforced concrete & masonry | in TGD®-Technology



The newly developed PREMIUM dry drill bit for hand-guided drilling impresses in many respects. With TGD®-Technology (TYROLIT GRAIN

DISTRIBUTION), a unique technology developed by TYROLIT for the optimised distribution of grain.

	Type no.	Dimension	Segment height	
	HOHLT	34418318	52 x 150 x M16	8.5
		34418319	57 x 150 x M16	8.5
		34418373	62 x 150 x M16	8.5
		34418379	68 x 150 x M16	8.5
		34418382	72 x 150 x M16	8.5
		34418317	82 x 150 x M16	8.5
		34209085	92 x 150 x M16	8.5
		34418385	102 x 150 x M16	8.5
		34418390	107 x 150 x M16	8.5
		34418402	112 x 150 x M16	8.5
		34418403	117 x 150 x M16	8.5
		34418544	122 x 150 x M16	8.5
		34418565	127 x 150 x M16	8.5
		34418549	132 x 150 x M16	8.5
		34418561	142 x 150 x M16	8.5
		34418563	152 x 150 x M16	8.5
		34418564	162 x 150 x M16	8.5



### DDE Dry drill bits

for lightly reinforced concrete & masonry | in TGD®-Technology



Perfect tool for installing sockets and junction boxes as well as smaller breakthrough jobs.

		Type no.	Dimension	Segment height
	HOHLT	34201286	68 × 70 × M16	11.3
		34201288	82 × 70 × M16	11.3



### DDL Dry drill bits

for lightly reinforced concrete & masonry



Quality tool for daily use, impressive performance and lifetime.

		Type no.	Dimension	Segment height
	HOHLT	899272	32 × 150 × M16	6.5
		899271	42 × 150 × M16	6.5
		252911	52 × 150 × M16	6.5
		252912	56 × 150 × M16	6.5
		252913	62 × 150 × M16	6.5
		252914	68 × 150 × M16	6.5
		252915	72 × 150 × M16	6.5
		252916	82 × 150 × M16	6.5
		252917	92 × 150 × M16	6.5
		252918	102 × 150 × M16	6.5
		252919	107 × 150 × M16	6.5
		34228775	111 × 150 × M16	6.5
		252920	117 × 150 × M16	6.5
		34228776	121 × 150 × M16	6.5
		252921	127 × 150 × M16	6.5
		34228777	131 × 150 × M16	6.5
		34228779	151 × 150 × M16	6.5
		252922	152 × 150 × M16	6.5
		252923	162 × 150 × M16	6.5
		252924	200 × 150 × M16	6.5



## DDL Dry drill bits for lightly reinforced concrete & masonry



Tool for installing sockets and junction boxes as well as smaller breakthrough jobs.

		Type no.	Dimension	Segment height
	HOHLT	650292	68 × 70 × M16	6.5
		34445860	72 × 70 × M16	6.5
		650293	82 × 70 × M16	6.5

## Dry drill bits accessories Compact universal dust extraction system



Dust extraction adapter compatible for dry drill bits with M16 connection

	Type no.	Description	Product info
	10983964	Dust extraction adapter with M16 connection on the tool side and M16 connection on the machine side	For attaching industrial vacuum cleaner
	10983845	Centering spike 140 mm	BASIC core drill PREMIUM core drill NL 70 mm
	10986189	Centering spike 233 mm	Core drill PREMIUM NL 150 mm

## Dry drill bits accessories Connections for all common machines



Adapter suitable for all commercial machines - with and without soft impact drill bit connection: M16.

	Type no.	Machine connection	Drill bit connection	Pilot drills / Centering spikes
	707824	5/8" Female	M16 Male	Centering spike 120/233 mm
	850026	5/8" Female	M16 Male	Pilot drill SDS
	116264	HEX SW12 Male	M16 Male	Pilot drill Konus
	707827	HEX SW12 Male	M16 Male	Centering spike 120/233 mm
	850011	HEX SW12 Male	M16 Male	Pilot drill SDS
	707831	SDS Male	M16 Male	Centering spike 120/233 mm
	707834	M18 Female	M16 Male	Centering spike 120/233 mm

## Dry drill bits accessories

### Centring aids





Pilot drill with SDS connection or cone facilitates the precise positioning of walls using 150 mm drill bits. the drill bits and enables exact results.

When using a centring shaft, openings can also be made in 30 cm thick

	Type no.	Description	Product info
	579420	Pilot drill SDS 160 mm	Core drill NL 60/70 mm
	579424	Pilot drill SDS 260 mm	Core drill NL 150 mm
	116263	Pilot drill taper 160 mm for adaptor 116264	Core drill NL 60/70 mm
	579503	Centering shaft SDS 250 mm	Core drill NL 150 mm

## Dry drill bits accessories



	Typennummer	Bezeichnung	Produktinfo
<b>Centering spikes</b> 	10999819	Centering spike 120 mm	Connection without dust extraction adapter Core drill NL 60/70 mm
	10983845	Centering spike 140 mm	With dust extraction adaptor 10983964 Core drill NL 60/70 mm
	10986189	Centering spike 233 mm	With dust extraction adaptor 10983964 Core drill NL 150 mm
<b>Abrasive grain</b>	34215616	Drilling Booster	Loose abrasive grain for sharpening during the application
<b>Sharpening plate</b> 	497322		55 × 25 × 320
	484627		160 × 30 × 320
	484672		320 × 55 × 320



# Tile drilling





## DDT Tile drills

for tiles and ceramic materials

+ **Maximum drilling comfort**  
thanks to optimised moistening  
of the diamonds with water and  
easy core removal.

+ **Fast, accurate drilling**  
no edge chipping.



+ **Universal use**  
for ceramictiles, fine stoneware  
and marble slabs.

TYROLIT vacuum brazed diamond  
coring bit for all ceramic tiles,  
fine stoneware and marble slabs.

Maximum drilling comfort, suitable for  
universal use with M14 connection  
for angle grinders, and adapter for

drilling machines. Suitable for dry and  
wet drilling. Perfect, chip-free drilling  
in tiled and sanitary areas.

## Tile drilling wet



**DDT Tile drills**  
for tiles and ceramic materials



		Type number	Dimension	Segment height
	HOHLT	34180136	5 × 35 × HEX	4
		69833	6 × 35 × HEX	4
		69848	8 × 35 × HEX	4
		69855	10 × 35 × HEX	4
		69856	12 × 35 × HEX	4
		69860	14 × 35 × HEX	4
		34562087	16 × 35 × HEX	4







## Tile drilling dry

★★★  
PREMIUM

**DDT Tile drills with paraffin**  
for tiles and ceramic materials





		Type number	Dimension	Segment height	
	HOHLT	34251679	6×35×M14	10	
		34251680	8×35×M14	10	
		34251711	10×35×M14	10	
		34251712	12×35×M14	10	
	HOHLT	34393075	5×67×HEX	10	
		34393071	6×67×HEX	10	
		34393072	8×80×HEX	10	
		34393073	10×80×HEX	10	
		34393074	12×80×HEX	10	
		34393076	14×80×HEX	10	

★★★  
PREMIUM

**DDT Tile drills**  
for tiles and ceramic materials



		Type number	Dimension	Segment height	
	HOHLT	69769	20×45×M14	4	
		34214903	25×45×M14	4	
		34214904	35×45×M14	4	
		69768	38×45×M14	4	
		34214905	42×45×M14	4	
		69767	52×45×M14	4	
		34369203	54×45×M14	4	
		69766	65×45×M14	4	
		34369204	68×45×M14	4	
		51392	75×45×M14	4	
		34369205	82×45×M14	4	

## Accessories tile drill bits

Adapter M14



	Type No.	Machine connection	Pilot drills
	69774	SDS	Pilot drill Konus
	69801	HEX	Pilot drill Konus

## Tile drill sets

★★★  
PREMIUM

### DDT Tile drill-set HEX Ø 5–14 for tiles and ceramic materials



Type No.	Content
34215809	Tile drills Ø 5, 6, 8, 10, 12, 14 mm Allen key

★★★  
PREMIUM

### DDT Tile drill-Set HEX Ø 5-14 with paraffin for tiles and ceramic materials



Type No.	Content
HOHLT 34393131	Tile drills Ø 5, 6, 8, 10, 12, 14 mm Allen key

★★★  
PREMIUM

### DDT Tile drill-Set HEX Ø 6+8 with paraffin for tiles and ceramic materials



Type No.	Content
HOHLT 34403124	Tile drills 2 × Ø 6, 2 × Ø 8 mm

★★★  
PREMIUM

### DDT Tile drill-Kit HEX for tiles and ceramic materials



Type No.	Content
34215843	Tile drills Ø 5, 6, 8, 10, 12, 14 mm Water bottle 1 l (Type No. 34215846) Drilling aid (Type No. 34215847) Allen key

★★★  
PREMIUM

### DDT Tile drill-set M14 Ø 20+ for tiles and ceramic materials



Type No.	Content
HOHLT 34229331	Tile drills Ø 20, 25, 35, 38, 42, 52, 65, 75 mm Adapter M14/HEX, M14/SDS Allen key Pilot drill 7 × 110 Open ended spanner SW19



★★★  
PREMIUM

### DDT Tile drill-set M14 for tiles and ceramic materials



Type no.	Content
34294535	Tile drills Ø 6, 8, 10, 12, 20, 25, 35 mm Wrench

★★★  
PREMIUM

### DDT Tile drill-set XL for tiles and ceramic materials



Type no.	Content
34245899	Tile drills HEX wet Ø 5, 6, 8, 10, 12, 14 mm Tile drills M14 dry Ø 20, 38, 52, 65, 75 mm 69774 SDS Adapter on request 69801 HEX Adapter on request Center Drill Ø 7 Open-ended spanner SW 19 Hex key 34215846 1 l Water bottle (hose included) 34215847 Drilling aid







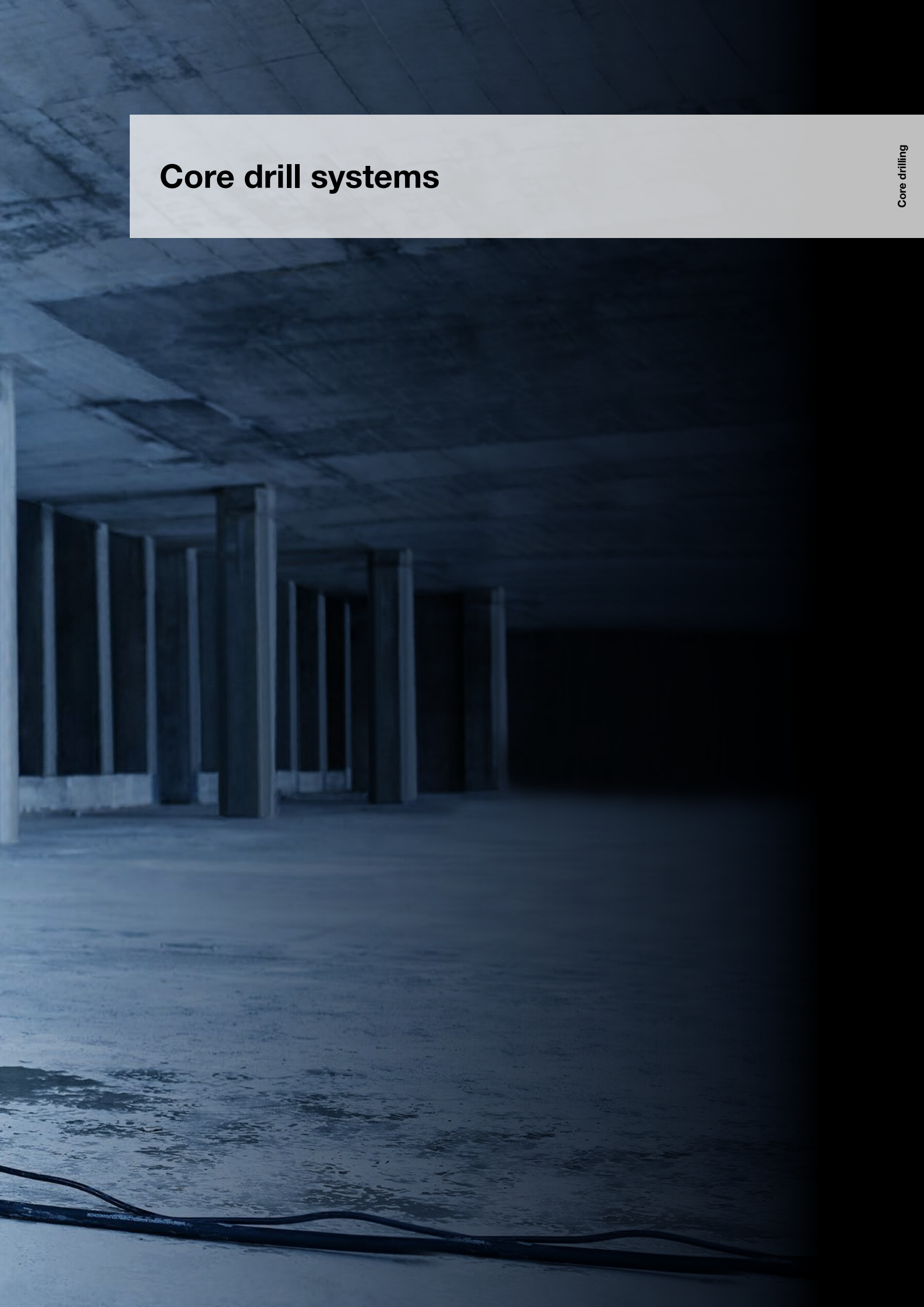























# Core drill systems



# Selecting guide for core drill systems

	Power in kW	Application	Drill diameter range in mm	Drill rig recommendation
 DME19DP	1.8	 	52	 DRU160
 DME17DP	2.0	 	30	 DRU160
 DME22SU	2.2	  	20	 DRA150
 DME20PU	2.0	  	15	 DRU160
 DME20PW	2.0	 	15	 DRU160
 DRS162	2.5		40	Integrated
 DRS250	2.5		50	Integrated

 wet

 dry

 also handheld



# Accessories









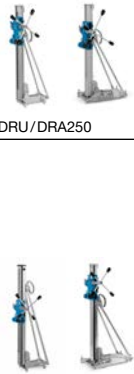

Adaptor M16	Dust vacuum adaptor dry, M16	Centering spike	Vakuüm fixing	Fastening bolt assembly	Quick grip device	Ceiling prop	Watertank	Water retention ring	Extension	ModulDrill™-distance plate	Antifriction-Element	Trolley chassis
●	●	●	●	●						●		
●	●	●	●	●						●		
	●	●	●	●			●	●	●			
		●	●	●	●		●	●	●		●	
		●	●	●	●		●	●	●		●	
			●	●			●		●		●	
			●	●	●		●		●		●	●

● available / suitable





	Power in kW	Application	Drill diameter range in mm	Drill rig recommendation
 <p>DME33MW, DME33UW</p>	3.3		<p>50</p> <p>250</p> <p>400</p>	 <p>DRU/DRA250</p> <p>DRU/DRA400</p>
 <p>DME52UW</p>	5.2		<p>100</p> <p>500</p>	 <p>DRA500</p>
 <p>DGB1000</p>			<p>150</p> <p>1000</p>	 <p>BC-2</p>



wet



dry



also handheld



Adaptor M16

Dust vacuum adaptor dry, M16

Centering spike

Vakuun fixing

Fastening bolt assembly

Quick grip device

Ceiling prop

Watertank

Water retention ring

Extension

ModulDrill™-distance plate

Antifriction-Element

Trolley chassis



★ ★ ★  
PREMIUM

## Drill motor DME19DP

Core drilling up to Ø 162 mm



System solution for dry drilling reinforced concrete



Activatable/deactivatable soft impact function accelerates work progress



Electronics for soft start and LED indicator for optimum drilling performance

The DME19DP in conjunction with TYROLIT TGD® dry drill bits is the solution for dry drilling applications in reinforced concrete. The practical centring aid ensures precise drill bit guidance and a longer diamond

tool lifetime. Switchable soft impact function accelerates work progress, particularly in hard materials. The soft start and the LED indicator aid the user in selecting the optimal drilling speed.



# System & Accessories

## Technical data

Drill motor DME19DP	
Voltage / Frequency	230 V / 50 Hz    110 V / 60 Hz
Type no.	10988200    10988700
Drill diameter range	52–162 mm
Max. drill diameter in reinforced concrete	122 mm
Nominal power	1.8 kW
Speed	1 150 rpm
Impact frequency	28 000/min
Motor cooling	Air
Tool attachment	1 ¼" and R ½"
Operation	Hand-held / rig-based
Application	Dry
Electronic overload cut-out	•
Mechanical overload cut-out	•
Drill rig attachment	Clamping collar 60 mm

## Dimensions & Weight

Length	510 mm
Width	95 mm
Height	170 mm
Weight	5.2 kg

## Accessories

976014	Vacuum set
10999500	VPE600 Vacuum pump 230V EU/CH
975381	Vacuum hose 3 m complete

## System & Accessories

Drill motor DME19DP	
10990100	Dry drill rig DRU160
10995437	Centering device for DRU160
10995156	Core stop ½"
10995087	ModulDrill™ clamping collar plate
11002426	Vacuum cleaner BBS 606 L

## Accessories

10997916	Centering spike 250 mm
10995373	Centering spike 450 mm
10995661	Centering insert Ø 52 mm
10995662	Centering insert Ø 62 mm
10995663	Centering insert Ø 68 mm
10995664	Centering insert Ø 72 mm
10995665	Centering insert Ø 82 mm
10995666	Centering insert Ø 92 mm
10995667	Centering insert Ø 102 mm
10995668	Centering insert Ø 112 mm
10995669	Centering insert Ø 122 mm
10995670	Centering insert Ø 127 mm
10995671	Centering insert Ø 132 mm
10995672	Centering insert Ø 142 mm
10995673	Centering insert Ø 152 mm
10995674	Centering insert Ø 162 mm
961955	Adaptor ½" > M16
10994032	Adaptor 1 ¼" > M16
10983964	Dust vacuum adaptor M16
10983845	Centering spike 140 mm
10986189	Centering spike 233 mm
497322	Sharpening plate
980304	Chisel 300 x 25 mm
34215616	Abrasive grain for dry drilling



## Drill motor DME17DP

Core drilling up to Ø 200 mm



2-speed transmission with switchable soft impact for optimal drilling performance



Integrated dust extraction for a clean working environment



Can be hand-held or drill-rig guided

The DME17 is a 2-speed dry drill motor for drilling diameters up to 200 mm. The powerful 2.0 kW motor, in combination with the switchable soft impact, enhances the drilling performance in reinforced concrete and in other hard materials. The machine can be both hand-held and drill-rig operated. The compact

design, low weight and integrated dust extraction system makes the core drill very user-friendly. This model is unique in that it is available in three speed versions (standard, slow and quick) and thus optimally covers the most varied of customer needs.

# System & Accessories

## Technical data

Drill motor	DME17DP	DME17DP-L	DME17DP-S
Nominal voltage/frequency		230 V/50-60 Hz	
Type no.	11000001	11000002	11000003
Drill diameter range	30-180 mm	40-200 mm	30-120 mm
Max. drill diameter in reinforced concrete	150 mm	180 mm	100 mm
Nominal power		2.0 kW	
Speed	700/1700 rpm	540/1200 rpm	900/1,700 rpm
Impact frequency	14,000/34,000 rpm	10,800/24,000 rpm	16,200/30,600 rpm
Motor cooling		Air	
Tool attachment		1 ¼"	
Operation		Hand-held / rig-based	
Application		Dry	
Electronic overload cut-out		•	
Mechanical overload cut-out		•	
Drill rig attachment		Clamping collar 60 mm	

## Dimensions & weight

Length	510 mm
Width	110 mm
Height	160 mm
Weight	5 kg

## System & Accessories

System & Accessories		Accessories	
11000002	Drill motor DME17DP-L	10985334	Centering spike 250-350 mm
10990100	Drill rig DRU160 dry	10984446	Centering spike 450 mm
10995437	Drill bit centring for DRU160	10994032	Adapter 1 ¼" > M16
10995087	ModulDrill™ clamping collar plate	10983964	Dust extraction adapter M16
		10983845	Centering spike 140 mm
		10986189	Centering spike 233 mm
		10986190	Strap wrench
		497322	Sharpening plate
		980304	Chisel 300 x 25 mm
		34215616	Abrasive grain for dry drilling

★★  
STANDARD

## Drill motor DME22SU

Core drilling up to Ø 180 mm



Three-speed transmission for optimum rotational speeds



Dry drilling with the included M16 adapter



Comes in a handy transport case

The DME22SU drill motor is ideal for electrical and installation work. It features a 3-speed transmission and variable speed setting with soft start.

Integrated overload cut-outs and the PRCD safety switch ensure safe working. Dry drilling is also possible with the included M16 adapter.



# System & Accessories

## Technical data

Drill motor DME22SU	
Voltage / Frequency	230 V / 50–60 Hz 110 V / 50–60 Hz
Type no.	10993027 10993028
Drill diameter range	20–180 mm
Nominal power	2.2 kW
Nominal current	9.5 A 18 A
Load speed	400/750/1 550 rpm
No load speed	850/1 650/3 450 rpm
Motor cooling	Air
Tool attachment (external)	1 ¼"
Tool attachment (internal)	½"
Operation	Hand-held / rig-based
Application	Wet / dry
Electronic overload cut-out	•
Mechanical overload cut-out	•
PRCD protection switch	•
Drill rig attachment	Clamping collar 60 mm

## Dimensions & Weight

Length	552 mm
Width	110 mm
Height	150 mm
Weight	6.0 kg

## System & Accessories

Core drilling system with DRU160 Drill rig	
10993027	Electric drill motor DME22SU
10987400	Drill rig DRU160
11002077	Fastening bolt assembly

## Accessories

400439	Extension ½" 100 mm
359475	Extension ½" 200 mm
359476	Extension ½" 300 mm
889232	Extension ½" 400 mm
707230	Extension ½" 500 mm
378198	Extension 1 ¼" 100 mm
359471	Extension 1 ¼" 200 mm
359472	Extension 1 ¼" 300 mm
359473	Extension 1 ¼" 400 mm
359474	Extension 1 ¼" 500 mm
10983964	Dust vacuum adaptor M16
10983845	Centering spike 140 mm
10986189	Centering spike 233 mm
10986190	Strap wrench

★★★  
PREMIUM

## Drill motors DME20PW | DME20PU

Core drilling up to Ø 180 mm

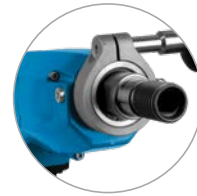

Performance and service indicator as well as levelling aid



Compact and ergonomic design



Quick changeover between wet and dry drilling with DME20PU

The DME20 drill motor provides impressive drilling performance in the power range up to 2 kW. The mechanical and electronic overload cut-out and the full metal housing ensure high reliability. Built-in performance

and service indicators, as well as the levelling aid, also enable easy operation. The drill motor is suitable for universal use and covers a wide variety of application areas: manual/drill-rig guided and wet/dry (DME20PU).

# System & Accessories

## Technical data

Drill motors	DME20PW		DME20PU	
	Voltage / Frequency	230 V / 50 Hz	110 V / 60 Hz	230 V / 50 Hz
Type no.	10992077	10992078	10992079	10992080
Drill diameter range	15–180 mm			
Nominal power	2.0 kW			
Nominal current	9.5 A	18 A	9.5 A	18 A
Load speed	520/1 400/2 900 rpm			
No load speed	830/2 200/4 600 rpm			
Motor cooling	Air			
Tool attachment (external)	1 ¼"			
Tool attachment (internal)	½"			
Operation	Hand-held / rig-based			
Application	Wet		Wet	
Electric overload cut-out	•			
Mechanical overload cut-out	•			
PRCD protection switch	•			
Performance indicator	•			
Service indicator	•			
Drill rig attachment	Clamping collar 60 mm			

## Dimensions & Weight

Length	435 mm	450 mm
Width	115 mm	
Height	300 mm	
Weight	6.3 kg	6.5 kg

## System & Accessories

Core drilling system with DRU160 Drill rig	
10992077	Electric drill motor DME20PW
10992079	Electric drill motor DME20PU
10987400	Drill rig DRU160
976014	Vakuum set
10999500	VPE600 Vacuum pump 230V EU/CH
975381	Vakuum hose 3 m complete
Accessories	
400439	Extension ½" 100 mm
359475	Extension ½" 200 mm
359476	Extension ½" 300 mm
889232	Extension ½" 400 mm
707230	Extension ½" 500 mm
378198	Extension 1 ¼" 100 mm
359471	Extension 1 ¼" 200 mm
359472	Extension 1 ¼" 300 mm
359473	Extension 1 ¼" 400 mm
359474	Extension 1 ¼" 500 mm
10996327	Centering spike 250–300 mm
10996328	Centering spike 400–450 mm
963339	Anti-friction element 1 ¼", max. 2.4 kW
974984	Supporting ring alum. 1 ¼"

★★★  
PREMIUM

## Drill motors DME33MW | DME33UW

Core drilling up to Ø 450 mm

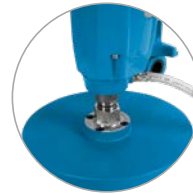

Large drilling diameter range up to 450 mm



Performance and service indicator as well as levelling aid



Practical carrying handle

Thanks to optimum torque adjustment, the DME33 is an extremely powerful drill motor providing impressive productivity. The mechanical and electronic overload cut-out and the full metal housing ensure high reliability.

Built-in performance and service indicators, as well as the levelling aid, also enable easy operation. The drill motor is available with different drill rig attachments (ModulDrill™ quick clamping system or universal plate).



# System & Accessories

## Technical data

Drill motors	DME33MW		DME33UW	
Voltage / Frequency	230 V / 50 Hz	110 V / 60 Hz	230 V / 50 Hz	110 V / 60 Hz
Type no.	10992085	10992086	10992087	10992088
Drill diameter range	50–450 mm			
Nominal power	3.3 kW			
Nominal current	15.9 A	30 A	15.9 A	30 A
Load speed	180/430/750 rpm			
No load speed	360/820/1 240 rpm			
Motor cooling	Air			
Tool attachment (external)	1 ¼"			
Operation	Rig-based			
Application	Wet			
Electric overload cut-out	•			
Mechanical overload cut-out	•			
PRCD protection switch	•			
Performance indicator	•			
Service indicator	•			
Drill rig attachment	ModulDrill™		Universal plate	

## Dimensions & Weight

Length	575 mm		
Width	145 mm		
Height	185 mm	180 mm	
Weight	13.7 kg	13.6 kg	

## System & Accessories

### Core drilling system with DRA400 (Steel dowel foot)

10992085	Electric drill motor DME33MW
10987600	Drill rig DRA400
964906	ModulDrill™-Distance plate Ø +180 mm
11002077	Fastening bolt assembly

### Core drilling system with DRU400 (Alu. dowel-vacuum foot)

10992085	Electric drill motor DME33MW
10984600	Drill rig DRU400
977368	Vacuum set
10999500	VPE600 Vacuum pump 230V EU/CH
975381	Vacuum hose 3 m complete

### Accessories

378198	Extension 1 ¼" 100 mm
359471	Extension 1 ¼" 200 mm
359472	Extension 1 ¼" 300 mm
359473	Extension 1 ¼" 400 mm
359474	Extension 1 ¼" 500 mm
969138	Adaptor 1 ¼" external – ½" internal
400439	Extension ½" 100 mm
359475	Extension ½" 200 mm
359476	Extension ½" 300 mm
889232	Extension ½" 400 mm
10992646	Easy release element



## Drill motor DME52UW

Core drilling up to Ø 500 mm



Powerful 5.2 kW motor for 400 V 3-phase power supply



3-speed-gear with oil bath lubrication, oil pump and overload clutch



Robust plastic-foil keyboard, LED performance indicator and Softstart

The DME52UW is a powerful, water-cooled 3-phase drill motor. Its 5.2 kW of power in combination with the oil-bath lubricated gearbox, provide optimum torque and rotation speed for a high drilling performance up to a maximum diameter of 500 mm. Full

metal housing, overload clutch and motor thermal protection as well as IP 55 protection class guarantee maximal reliability. LED performance indicator, Softstart and antifriction-element ensure user friendly operation.

# System & Accessories

## Technical data

<b>Drill motor DME52UW</b>	
Nominal voltage/frequency	400 V / 50-60 Hz
Item no.	10998818
Drilling diameter range	110–500 mm
Motor power	5.2 kW
Nominal current	9.5 A
Load speed	140/280/430 rpm
No load speed	140/280/430 rpm
Motor cooling	Water
Tool attachment	1 ¼"
Operation	Drill-rig guided
Application	Wet
Mechanical overload cut-out	•
Electronic overload cut-out	•
Drill-rig attachment	Universal plate

## Dimensions & weight

Length	580 mm
Width	150 mm
Height	170 mm
Weight	22.9 kg

## System & Accessories

<b>Core drilling system DRA500 (steel dowel foot)</b>	
10998818	Drill motor DME52UW
10987700	Drill rig DRA500
977464	ModulDrill mounting plate
964907	ModulDrill distance plate Ø +250 mm
11002077	Fastening bolt assembly for concrete

## Accessories

<b>Core drilling system</b>	
378198	Extension 1 1/4" 100 mm
359471	Extension 1 1/4" 200 mm
359472	Extension 1 1/4" 300 mm
359473	Extension 1 1/4" 400 mm
359474	Extension 1 1/4" 500 mm

## Drill hammer DHE32

Universal drill hammer up to Ø 32 mm



900 W combi drill hammer for drilling, hammer drilling and chiselling



Quick tool change system for SDS Plus drill bits



Ideal for setting anchors

The 900-watt DHE32 combi drill hammer features drilling, hammer drilling, chiselling and chisel adjustment, making it the ideal all-rounder for minor chiselling work as well as setting anchors. This model is simple to use due to the

quick tool change system, tool-less drill chuck removal, accelerator switch and long-term operation option. It has a highly ergonomic design combining low vibrations with high impact energy and a non-rotating additional handle.

# System & Accessories

## Technical data

Max. drill Ø in concrete	32 mm
Max. drill Ø in masonry (HM drill bit)	82 mm
Max. drill Ø in steel	13 mm
Max. drill Ø in wood	32 mm
Tool attachment	SDS plus
Range of drill chuck	1.5–13 mm

## Drive

Drive / motor	Electric
Voltage / frequency	220-240 V/50-60 Hz
Motor power	900 W
No load speed	0–850/min
Idling stroke rate	0–3700/min
Max. single stroke impact energy	4.8 J

## Dimensions & weight

Length	400 mm
Width	86 mm
Height	235 mm
Weight	4.6 kg
Cable length	4 m

## System & Accessories

<b>Drill hammer DHE32</b>	
11002624	Drill hammer DHE32/230 V incl. 16 mm drill





## Modular electric drilling gearbox DGB1000

Core drilling up to Ø 1 000 mm



Optimised drill bit attachment for large bore drilling

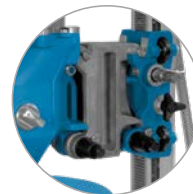

ModulDrill™ quick change clamping system for quick, easy and safe attachment



Bores with a diameter of up to 1 000 mm with Modul-Drill™ distance plates

In accordance with the TYROLIT modularity principle, the DGB1000 delivers optimum rotational speeds and impressive performance in

conjunction with either the electric high-frequency motor or hydraulic standard motor options, by means of 8 transmission stages – two speeds

at the drilling gear box and up to four stages via the relevant drive. With optimised drill bit attachment for large diameters and high torques.

### Technical data

#### Modular drilling gearbox

Nominal power (32 A)	20 kW
Motor power S1 (32 A)	17 kW
Drill diameter range with DRA500	150–500 mm
Drill diameter range with BC-2	150–1 000 mm

#### Dimensions & weight

Length	338 mm
Width	213 mm
Height	226 mm
Weight	15.7 kg

#### Design

2-stage gearbox
Special large hole flange
ModulDrill™ quick change clamping system

# System recommendation

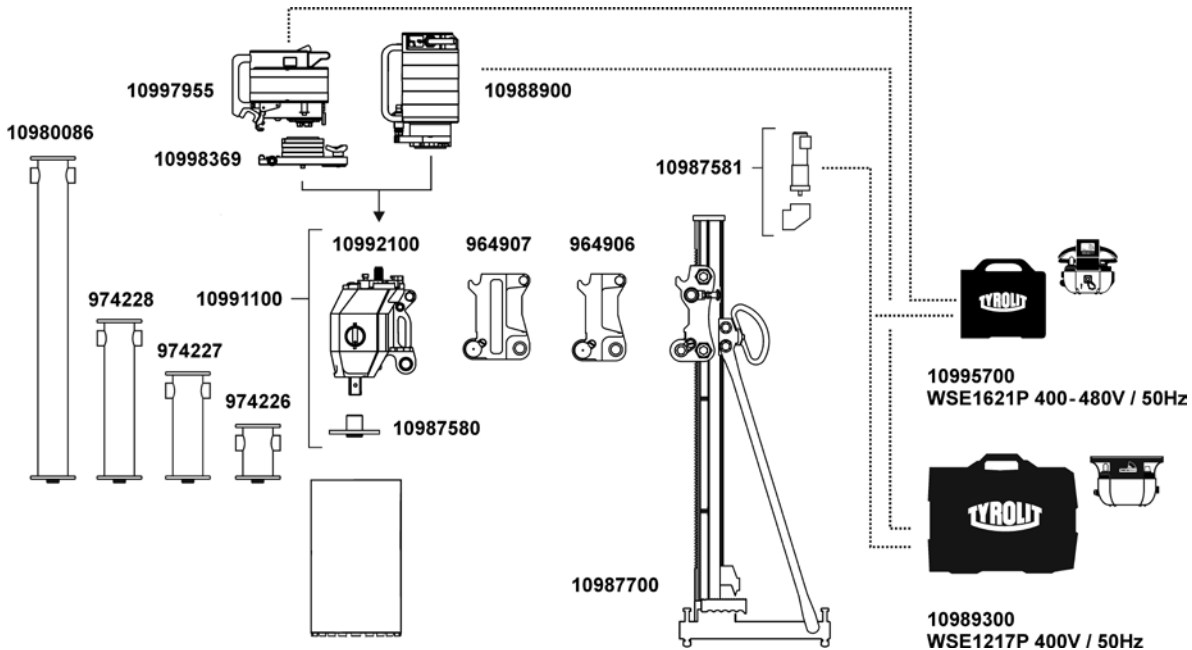

Core drilling system electric from Ø 150 mm to Ø 500 mm

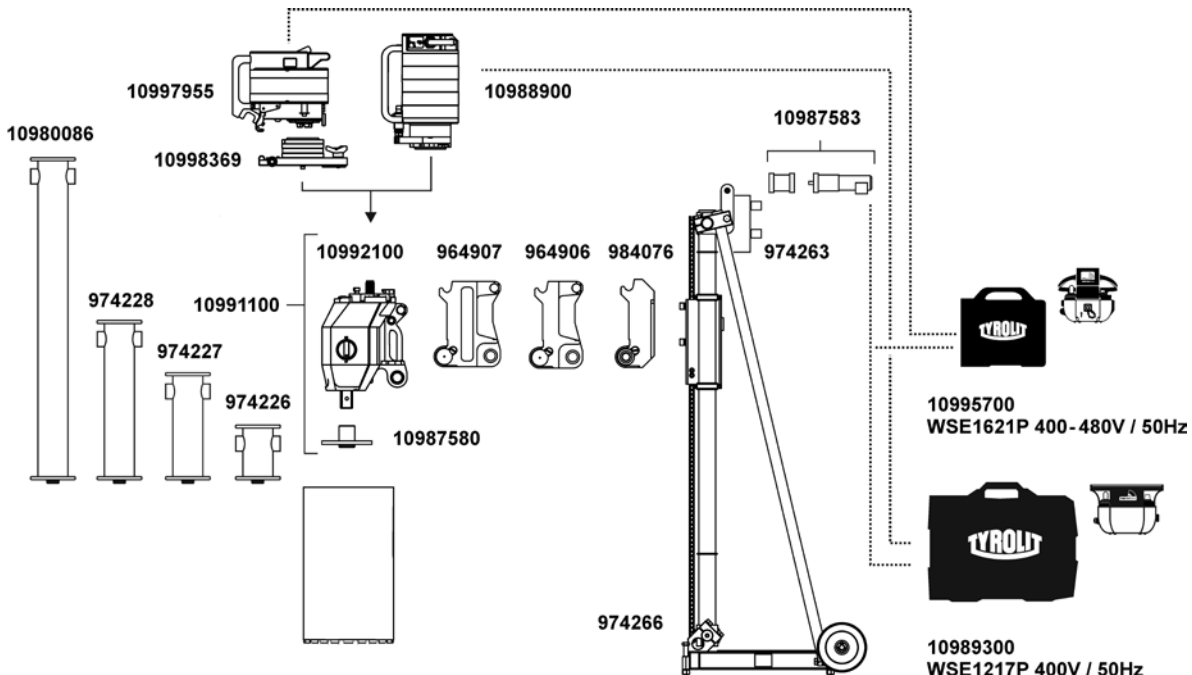

Core drilling system electric from Ø 150 mm to Ø 1 000 mm



# Modular hydraulic drilling gearbox DGB1000

Core drilling up to  $\varnothing$  1 000 mm



Optimised drill bit attachment for large bore drilling

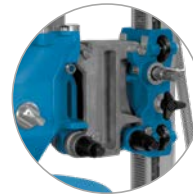

ModulDrill™ quick change clamping system for quick, easy and safe attachment



Bores with a diameter of up to 1 000 mm with Modul-Drill™ distance plates

In accordance with the TYROLIT modularity principle, the DGB1000 delivers optimum rotational speeds and impressive performance in

conjunction with either the electric high-frequency motor or hydraulic standard motor options, by means of 8 transmission stages – two speeds

at the drilling gear box and up to four stages via the relevant drive. With optimised drill bit attachment for large diameters and high torques.

## Technical data

### Modular drilling gearbox

Output	20 kW / 25 kW
Drill diameter range with DRA500	150–500 mm
Drill diameter range with BC-2	150–1 000 mm

### Design

2-stage gearbox
Special large hole flange
ModulDrill™ quick change clamping system

### Dimensions & weight

Length	338 mm
Width	213 mm
Height	226 mm
Weight	15.7 kg

# System recommendation

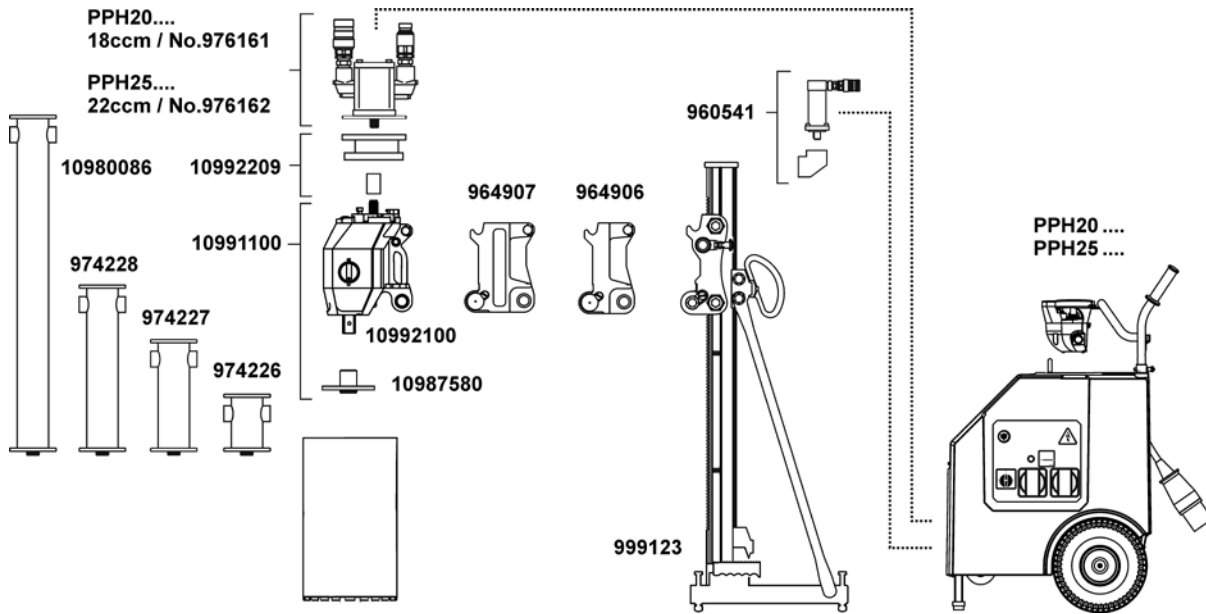

Core drilling system hydraulic from Ø 150 mm to Ø 500 mm

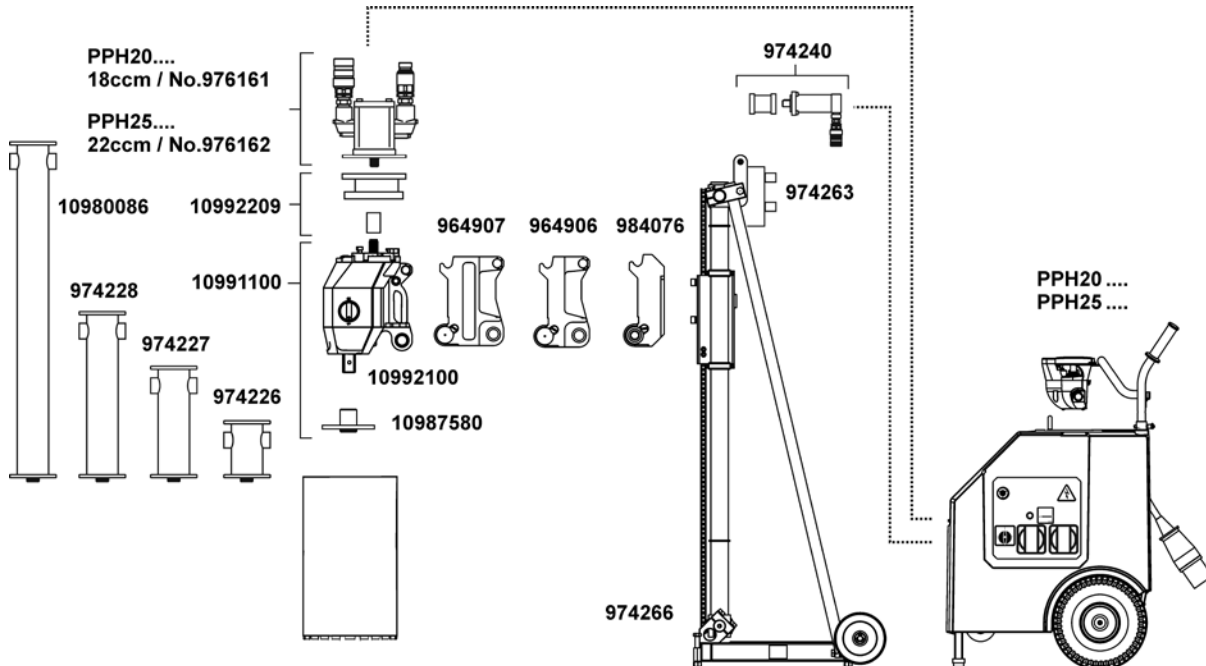

Core drilling system hydraulic from Ø 150 mm to Ø 1 000 mm

★★  
STANDARD

## Core drilling system DRS162

Core drilling up to Ø 162 mm



Powerful 2.5 kW Motor



One speed for drilling diameters up to 162 mm



Space-saving attachment facility via dowel foot

The DRS162 drill system is the ideal core drill entry model. The drill motor and drill rig complement each other perfectly and form a single unit. The preset speed and compact, lightweight construction guarantee easy

handling and user-friendliness. An integrated PRCD safety switch ensures maximum safety. Optional vacuum plate offers more flexibility in fixing the system.



# System & Accessories

## Technical data

Drill rig (integrated)	
Bore hole diameter	40–162 mm
Max. drill bit length	556 mm

Drill rig (integrated)	
Drill diameter range in concrete ca.	40–162 mm
Nominal power	2.5 kW
Nominal current	11.5 A
Nom. voltage / frequency standard	230 V / 50 Hz
Load speed	450 rpm
Cooling	Air cooling
Tool attachment external thread	1 ¼"
Tool attachment internal thread	½"
Operation	Drill rig operation
Application	Wet
Electronic overload cut-out	
Mechanical overload cut-out	
PRCD protection switch	

## Design

Aluminium dowel foot	
Feed using hand crank	
Adjustable feet (M12)	
1 handle	
Motor fixed integrated	

## Dimensions & Weight

Length	365 mm
Width	185 mm
Height	855 mm
Weight (drilling system)	15.5 kg

## System & Accessories

Core drilling system DRS162	
10990700	Core drilling system DRS162 / 230 V (dowel feet)
10993966	Fastening bolt assembly

Accessories	
974270	Extraction device for core bits
977353	Extraction device for cores
11002624	Drill hammer DHE32 / 230 V incl. 16 mm drill
10991465	Water tank 10 l
10993961	Vacuum plate complete
10999500	VPE600 Vacuum pump 230V EU/CH
975381	Vacuum hose complete 3 m



## Core drilling system DRS250

Core drilling up to Ø 250 mm



Drilling diameter up to 250 mm with 2-speed gearbox



Powerful 2.5 kW motor



Space-saving fixing option via dowel foot

The DRS250 drilling system combines simplicity with a large drill diameter range. The drill motor and drill rig complement each other and form a single unit. 2-speed oil bath gearbox insures perfect lubrication in all working positions, as well as optimal torque-to-speed ratio. Compact

and lightweight construction guarantees easy handling and user-friendliness. Mechanical overload clutch and integrated PRCD safety switch ensure maximum safety. Optional vacuum plate offers more flexibility in fixing the system.

# System & Accessories

## Technical data

Drill rig (integrated)	
Bore hole diameter	50 - 250 mm
Max. drill bit length	600 mm

Drill rig (integrated)	
Nominal power	2.5 kW
Nominal current	11.5 A
Nom. voltage / frequency	230 V / 50 - 60 Hz
Load speed	360 / 850 rpm
Cooling	Air cooling
Tool attachment	1 ¼"
Operation	Drill rig operation
Application	Wet
Mechanical overload cut-out	
PRCD protection switch	

## Design

Aluminium dowel foot
Feed using hand crank
Adjustable feet (M12)
Carrying handle
Detachable motor

## Dimensions & Weight

Length	295 mm
Width	195 mm
Height	1 069 mm
Weight (drilling system)	25.6 kg

## System & Accessories

Core drilling system DRS250	
10999880	Core drilling system DRS250 / 230 V (dowel feet)
10993966	Fastening bolt assembly

Accessories	
974270	Extraction device for core bits
977353	Extraction device for cores
11002624	Drill hammer DHE32 / 230 V incl. 16 mm drill
10991465	Water tank 10 l
975378	Vacuum plate complete
10999500	VPE600 Vacuum pump 230V EU/CH
975381	Vacuum hose complete 3 m
11000617	Trolley chassis DRS250

★★  
STANDARD

## Drill rig DRA150

Core drilling up to Ø 152 mm

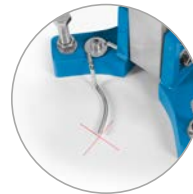

Integrated centre indicator

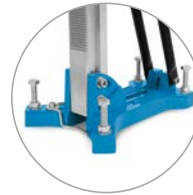

Compact dowel foot

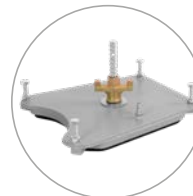

Optional vacuum plate

The DRA150 is extremely well-suited for electrical and installation work. This drill rig is suitable for 550 mm drill bits and angle drilling. A centre indicator, spirit level and carrying handle facilitate handling.

# System & Accessories

## Technical data

Drill rig DRA150	
Drill diameter range	20–152 mm
Max. drill bit length	550 mm

## Design

Dowel foot
Feed using hand crank
Diagonal adjustment 90°–45°
Centre indicator
Angle indicator
Spirit level
Adjustable feet
Handle
Clamping collar Ø 60 mm

## Dimensions & Weight

Length	330 mm
Width	240 mm
Height	950 mm
Weight	9.5 kg

## System & Accessories

Core drilling system with DRA150	
10993967	Drill rig DRA150
10993027	Electric drill motor DME22SU
10993966	Fastening bolt assembly

## Accessories

10993961	Vacuum plate complete
10999500	VPE600 Vacuum pump 230V EU/CH
975381	Vacuum hose 3 m komplett
11002624	Drill hammer DHE32 / 230 V incl. 16 mm drill
10993964	Water retention ring complete Ø 152 mm
10993965	Gasket Ø 152 mm
974270	Extraction device for core bits
977353	Extraction device for cores
10991465	Water tank 10 l



★★★  
PREMIUM

## Drill rig DRU160

Core drilling up to Ø 160 mm



Precision work due to high quality support with sturdy roller guide



Universal field of application thanks to 90°-45° diagonal adjustment



Efficient drill rig set-up using a standard centre indicator

The DRU160 is the lightweight among drill rigs up to Ø 160 mm.

The standardised clamping collar system enables quick mounting of common drill motors. In addition, a centre indicator, angle indicator and

spirit level enhance user-friendliness and help save valuable time during drill rig set-up. The anchor or vacuum attachment facility also increase flexibility.

# System & Accessories

## Technical data

Drill rig DRU160	
Drill diameter range	15–160 mm
Max. drill diameter with water collecting ring	130 mm
Max. drill bit length	560 mm

## Design

Aluminium dowel-vacuum foot
Feed using hand crank
Diagonal adjustment 90°–45°
Centre indicator
Angle indicator
Spirit level
Adjustable feet (M12)
Adjustable and interchangeable roller guides
2 handles
Clamping collar Ø 60 mm

## Dimensions & Weight

Length	400 mm
Width	200 mm
Height	866 mm
Weight	9 kg

## System recommendation

Core drilling system with DRU160	
10987400	Drill rig DRU160
10992077	Electric drill motor DME20PW
976014	Vacuum set
10999500	VPE600 Vacuum pump 230V EU/CH
975381	Vacuum hose 3 m complete

## System & Accessories

Accessories	
976014	Vacuum set
10999500	VPE600 Vacuum pump 230V EU/CH
975381	Vacuum hose 3 m complete
977394	Quick grip device, 1.7–3.1 m
977448	Clamp for quick grip device, 1.7–3.1 m
11000588	Fastening bolt assembly for vacuum base
11000589	Fastening bolt assembly (masonry), for vacuum base
11002624	Drill hammer DHE32 / 230 V incl. 16 mm drill
976136	Water retention ring complete Ø 70 mm
976134	Water retention ring complete Ø 130 mm
977437	Water retention ring holder, with centering device
977348	Gasket Ø 70 mm
976128	Gasket Ø 130 mm
974270	Extraction device for core bits
977353	Extraction device for cores
976616	Tool bag
10991465	Water tank 10 l



## Drill rigs DRA250 | DRU250

Core drilling up to Ø 250 mm



ModulDrill™ quick change clamping system – quick, easy and safe drill motor attachment



Non-strenuous, ergonomic working thanks to fine feed operation ( $i=1:3.5$ )

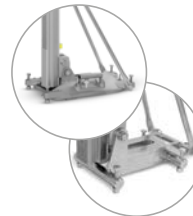

DRU250 with aluminium dowel-vacuum base. Drilling in the most restricted space with steel dowel foot DRA250

The DRA250 | DRU250 drill rigs offer impressive stability and drilling performance thanks to sturdy workmanship and robust drilling columns with wide gear teeth. The optimised support with sturdy roller guide guarantees precise drilling. The proven ModulDrill™ quick clamping system enables fast and secure

mounting of drill motors. In addition, a centre indicator (DRU250), angle indicator and two-speed feed gear enhance user-friendliness and help save valuable working time. The compact lightweight construction for easy transport, assembly and disassembly complete the system.

# System & Accessories



## Technical data

Drill rigs	DRA250	DRU250
Drill diameter range	40–250 mm	
Max. drill diameter with water collecting ring	200 mm	
Max. drill bit length	600 mm	582 mm

## Design

Aluminium dowel-vacuum foot (DRU250)		
Steel dowel foot (DRA250)		
Two speed feed gearbox $i=1:1$ & $i=1:3.5$		
Feed using hand crank		
Diagonal adjustment $90^\circ-45^\circ$		
Centre indicator (DRU250)		
Angle indicator		
Spirit level		
Adjustable feet (M12)		
Adjustable and interchangeable roller guides		
Handle	1 piece	2 pieces
ModulDrill™ quick change clamping system		

## Dimensions & Weight

Length	305 mm	447 mm
Width	205 mm	250 mm
Height	933 mm	908 mm
Weight	17 kg	14 kg

## System recommendation

### Core drilling system with DRA250 (Steel dowel foot)

10987500	Drill rig DRA250
10992085	El. drill motor DME33MW
11002077	Fastening bolt assembly

### Accessories DRA250

975378	Vacuum plate complete
10999500	VPE600 Vacuum pump 230V EU/CH
975381	Vacuum hose 3 m complete

961614	Ceiling prop
977394	Quick grip device, 1.7–3.1 m
977448	Clamp for quick grip device, 1.7–3.1 m
11002077	Fastening bolt assembly (concret)
977464	ModulDrill™ mounting plate
11002624	Drill hammer DHE32 / 230 V incl. 16 mm drill
974270	Extraction device for core bits
977353	Extraction device for cores
977392	Trolley chassis
967588	Tool bag
10991465	Water tank 10 l

### Core drilling system with DRU250 (Dowel-vacuum foot)

10984500	Drill rig DRU250
10992085	Electric drill motor DME33MW
960795	Vacuum set
10999500	VPE600 Vacuum pump 230V EU/CH
975381	Vacuum hose 3 m complete

### Accessories DRU250

960795	Vacuum set
10999500	VPE600 Vacuum pump 230V EU/CH
975381	Vacuum hose 3 m complete
961614	Ceiling prop
977394	Quick grip device, 1.7–3.1 m
977448	Clamp for quick grip device, 1.7–3.1 m
11000588	Fastening bolt assembly for vacuum base
11000589	Fastening bolt assembly (masonry), for vacuum base
977464	ModulDrill™ mounting plate
11002624	Drill hammer DHE32 / 230 V incl. 16 mm drill
10988902	Water retention ring complete $\varnothing$ 200 mm
960785	Water retention ring holder, with centering device
960693	Gasket $\varnothing$ 200 mm
974270	Extraction device for core bits
977353	Extraction device for cores
977392	Trolley chassis
967588	Tool bag
10991465	Water tank 10 l

★ ★  
STANDARD

## Drill rig BY

Core drilling up to Ø 300 mm



2-column guide principle  
with chain drive



Fixed, ergonomic position of  
handwheel



Compact design without  
support rods

The BY dual rod drill rig combines a lightweight design with great stability. The accurate guide principle enables inclined drilling at any angle. This particularly compact core drill rig can

be combined with a wide range of electric drilling motors. Thanks to its modular design, the drill rig can also be used for more powerful hydraulic drilling operations.



# System & Accessories

## Technical data

### Drill rigs BY

Drilling diameter range	80-300 mm
Max. drill bit length	520 mm

### Design

Dual rod guide principle
Chain drive
0°-90° diagonal adjustment

Feed via a handwheel

Ergonomic handwheel position

Steel dowel foot

ModulDrill™ quick clamping system

Optional feed gear 1:3

Optional double support bar

### Dimensions & weight

Length	410 mm
Width	230 mm
Height	1,115 mm
Weight (core drilling system)	21 kg

## System & Accessories

### System proposal

974229	Drill rigs BY
977462	Handwheel
984076	MudulDrill™ mounting plate
10992085	Drill motor DME33MWP
974238	Feed gear 1:3 (optional)
976139	Double support bar (optional)

### Accessories

11002077	Fastening bolt assembly for concrete
11002624	Drill hammer DHE32 / 230 V incl. 16 mm drill
974270	Extraction device for core bits
977353	Extraction device for cores
10991465	Watertank 10 l

★★★  
PREMIUM

## Core drilling system DRU350

Core drilling up to Ø 350 mm

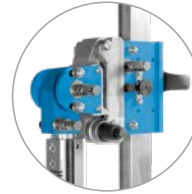

Maximum flexibility thanks to drilling and gripping column that can be rotated by 360°



Quick assembly and disassembly thanks to innovative telescope clamping system

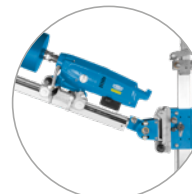

Easy diagonal drilling due to intelligent design

Thanks to its intelligent design with drilling and gripping column that can be rotated by 360°, the DRU350 enables the drilling of holes in walls, ceilings and floors. The drill rig can be mounted in a time saving and

material protecting manner via an innovative telescope clamping system. Various settings options, an extended drilling column and a variety of drill accessories ensure universal use.

# System & Accessories



## Technical data

### Drill rig DRU350

Drill diameter range	50–260 mm
Max. drill diameter with distance plate 180 mm	350 mm
Max. drill bit length	760 mm

### Design

Aluminium dowel foot
Telescopic clamping system
Two-speed feed gearbox $i=1:1$ & $i=1:3.5$
Feed using hand crank
Angular adjustment $0^\circ$ – $180^\circ$
Drilling and gripping column, rotatable by $360^\circ$
Included undercarriage
Adjustable feet
Adjustable interchangeable precision guides
1 handle
ModulDrill™ quick release clamping system

### Dimensions & Weight

Length	380 mm
Width	250 mm
Height	1 860 mm
Weight	48 kg

## System & Accessories

### Core drilling system DRU350

10984112	Drill rig DRU350
10992085	Electric drill motor DME33MW
964906	ModulDrill™ distance plate $\varnothing +180$ mm

### Accessories

10984542	1 m column extension
964906	ModulDrill™ distance plate $\varnothing +180$ mm
977464	ModulDrill™ mounting plate
974270	Extraction device for core bits
977353	Extraction device for cores
10991465	Water tank 10 l



## Drill rigs DRA400 | DRU400

Core drilling up to Ø 400 mm



Easily adjustable and interchangeable low wear roller guide



Easy diagonal drilling thanks to angle indicator



DRA400 with steel dowel foot. DRU400 vacuum fixing - drilling or dowel fixing

DRA400 and DRU400, the professional core drilling systems for a versatile application range. The optimised support with sturdy roller guide guarantees precise drilling. The proven ModulDrill™ quick clamping system enables fast and secure mounting of drill motors. In addition,

a centre indicator, angle indicator and two-speed feed gear enhance user-friendliness and help save valuable working time. The compact lightweight construction for easy transport, assembly and disassembly complete the system.

# System & Accessories



## Technical data

Drill rigs	DRA400	DRU400
Drill diameter range	50–250 mm	
Max. drill diameter with distance plate 180 mm	400 mm	400 mm (250 mm*)
Max. drill diameter with water collecting ring	250 mm	
Max. drill bit length	746 mm	737 mm

\* with vacuum fixing

## Design

Aluminium dowel vacuum foot (DRU400)		
Steel dowel foot (DRA400)		
Two speed feed gearbox $i=1:1$ & $i=1:3.5$		
Feed using hand crank		
Diagonal adjustment $90^\circ-45^\circ$		
Centre indicator (DRU400)		
Angle indicator		
Spirit level		
Adjustable feet (M12)		
Adjustable and interchangeable roller guides		
Handle	1 piece	2 piece
ModulDrill™ quick change clamping system		

## Dimensions & Weight

Length	305 mm	507 mm
Width	205 mm	300 mm
Height	1 055 mm	1 063 mm
Weight	19 kg	18 kg

## System recommendation

### Core drilling system with DRU400

10984600	Drill rig DRU400
10992085	El.drill. motor DME33MW
977368	Vacuum plate
10999500	VPE600 Vacuum pump 230V EU/CH
975381	Vacuum hose 3 m complete

### Accessories DRU400

977368	Vacuum plate
10999500	VPE600 Vacuum pump 230V EU/CH

975381	Vacuum hose 3 m complete
961614	Ceiling prop
977394	Quick grip device, 1.7–3.1 m
977448	Clamp for quick grip device, 1.7–3.1 m
11000588	Fastening bolt assembly for vacuum base
11000589	Fastening bolt assembly (masonry), for vacuum base
11002624	Drill hammer DHE32 / 230 V incl. 16 mm drill
964906	ModulDrill™ distance plate $\varnothing +180$ mm
977464	ModulDrill™ mounting plate
10988898	Water retention ring complete $\varnothing 250$ mm
977438	Water retention ring holder complete
977447	Gasket $\varnothing 250$ mm
974270	Extraction device for core bits
977353	Extraction device for cores
977392	Trolley chassis
967588	Tool bag
10991465	Water tank 10 l

### Core drilling system with DRA400

10987600	Drill rig DRA400
10992085	Electric drill motor DME33MW
964906	ModulDrill™ distance plate $\varnothing +180$ mm
11002077	Fastening bolt assembly dowel feet

### Accessories DRA400

975378	Vacuum plate complete
10999500	VPE600 Vacuum pump 230V EU/CH
975381	Vacuum hose 3 m complete
961614	Ceiling prop
977394	Quick grip device, 1.7–3.1 m
977448	Clamp for quick grip device, 1.7–3.1 m
11002077	Fastening bolt assembly concrete dowel feet
964906	ModulDrill™ distance plate $\varnothing +180$ mm
11002624	Drill hammer DHE32 / 230 V incl. 16 mm drill
977464	ModulDrill™ mounting plate
974270	Extraction device for core bits
977353	Extraction device for cores
977392	Trolley chassis
967588	Tool bag
10991465	Water tank 10 l

★ ★ ★  
PREMIUM

## Core drilling system DRA500 electric

Core drilling up to Ø 500 mm



Drilling column extensions  
from 230 to 910 mm



Maximum load capacity due  
to extra wide, high quality  
drilling column gearing

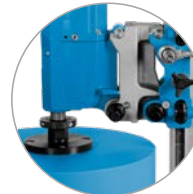

Bores with a diameter of up  
to 500 mm with ModulDrill™  
distance plates

The DRA500, a drill rig for maximum stability and the highest demands during drilling. The proven ModulDrill™ quick clamping system enables fast and secure mounting of drill motors. Thanks to an extended

drilling column, even long through-holes can be made with ease. Thanks to the modular design, combined use with TYROLIT cable saws and hydraulic equipment is possible without difficulty.



# System & Accessories



## Technical data

### Drill rig DRA500

Drill diameter range	100–300 mm
Max. drill diameter with distance plate 180 mm	450 mm
Max. drill diameter with distance plate 250 mm	500 mm
Max. drill bit length	869 mm

### Design

Steel dowel foot
Two speed feed gearbox $i=1:1$ & $i=1:3.5$
Feed using hand crank
Diagonal adjustment $90^\circ-45^\circ$
Centre indicator
Angle indicator
Adjustable feet (M12)
Adjustable and interchangeable roller guides
3 handles
ModulDrill™ quick change clamping system

### Dimensions & Weight

Length	454 mm
Width	301 mm
Height	1 182 mm
Weight	26 kg

## System & Accessories

### Core drilling system DRA500

10998818	Drill motor DME52UW
10987700	Drill rig DRA500
964907	ModulDrill™ distance plate $\varnothing +250$ mm
11002077	Fastening bolt assembly

### Accessories

977394	Quick grip device, 1.7–3.1 m
977448	Clamp for quick grip device, 1.7–3.1 m
11002077	Fastening bolt assembly
11002624	Drill hammer DHE32 / 230 V incl. 16 mm drill
984969	Rig extension 230 mm
984970	Rig extension 460 mm
984971	Rig extension 910 mm
977446	Additional support for rig extension, 910 mm
964906	ModulDrill™ distance plate $\varnothing +180$ mm
964907	ModulDrill™ distance plate $\varnothing +250$ mm
977464	ModulDrill™ mounting plate
974270	Extraction device for core bits
977353	Extraction device for cores
977392	Trolley chassis
964378	Tool box
10991465	Water tank 10 l

★★★  
PREMIUM

## Core drilling system DRA500 hydraulic

Core drilling up to Ø 500 mm



Time saving drill motor mounting via ModulDrill™ quick clamping system



Continuously variable drilling adjustment with powerful hydraulic feed



Maximum stability with sturdy, two-piece pillar support at the rear

The DRA500, a drill rig for maximum stability and the highest demands during drilling. The proven ModulDrill™ quick clamping system enables fast and secure mounting of drill motors. Thanks to an extended

drilling column, even long through-holes can be made with ease. Thanks to the modular design, combined use with TYROLIT cable saws and electric equipment is possible without difficulty.

# System & Accessories



## Technical data

### Drill rig DRA500

Drill diameter range	100–250 mm
Max. drill diameter with distance plate 180 mm (Gearbox)	400 mm
Max. drill diameter with distance plate 250 mm (Gearbox)	500 mm
Max. drill bit length	825 mm

### Design

Steel dowel foot
Two speed feed gearbox $i=1:1$ & $i=1:3.5$
Feed using hand crank or hydraulic drive
Diagonal adjustment $90^\circ-45^\circ$
Centre indicator
Angle indicator
Adjustable feet (M12)
Adjustable and interchangeable roller guides
3 handles
ModulDrill™ quick change clamping system

### Dimensions & Weight

Length	454 mm
Width	301 mm
Height	1 182 mm
Weight	26 kg

## System & Accessories

### Core drilling system DRA500

10987700	Drill rig DRA500
976032	Motor complete B 145 ccm / FD incl. PRV*
974276	Drill spindle 1 ¼" complete incl. key
960630	ModulDrill™ spindle clamp 250 mm
960541	Hydraulic feed unit
11002077	Fastening bolt assembly

### Accessories

977394	Quick grip device, 1.7–3.1 m
977448	Clamp for quick grip device, 1.7–3.1 m
11002077	Fastening bolt assembly
11002624	Drill hammer DHE32 / 230 V incl. 16 mm drill
984969	Rig extension 230 mm
984970	Rig extension 460 mm
984971	Rig extension 910 mm
977446	Additional support for rig extension, 910 mm
964906	ModulDrill™ distance plate $\varnothing +180$ mm
964907	ModulDrill™ distance plate $\varnothing +250$ mm
974270	Extraction device for core bits
977353	Extraction device for cores
977392	Trolley chassis
964378	Tool box
10991465	Water tank 10 l

## Hydraulic drill motors (on drill spindle)

### With hydraulic feed

976156	Motor complete B 75 ccm / FD incl. PRV*
976157	Motor complete B 100 ccm / FD incl. PRV*
976032	Motor complete B 145 ccm / FD incl. PRV*
976033	Motor complete B 160 ccm / FD incl. PRV*

### With manual feed (with control valve)

976146	Motor unit B 60 ccm / FD incl. PRV*
976147	Motor unit B 75 ccm / FD incl. PRV*
976148	Motor unit B 100 ccm / FD incl. PRV*
976023	Motor unit B 145 ccm / FD incl. PRV*
976024	Motor unit B 160 ccm / FD incl. PRV*

\* PRV = Pressure control valve



## Core drilling system BC-2 electric

Core drilling up to  $\varnothing$  1 000 mm

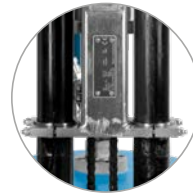

High stability yet low weight thanks to 2-pillar guide system

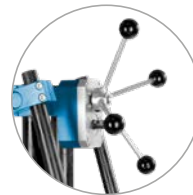

Effortless drilling thanks to two speed feed gearbox  $i=1:2$  and  $i=1:9$



Bores with a diameter of up to 1 000 mm with Modul-Drill™ distance plates

The BC-2 is ideal for drilling large holes up to 1 000 mm. Thanks to the modular design, combined use with TYROLIT cable saws and hydraulic equipment is possible without

difficulty. The dual-column guidance principle and a two-speed feed gear enable user friendly work and low weight. A large selection of drill accessories rounds off the range.

# System & Accessories



## Technical data

### Drill rig BC-2

Drill diameter range	100–400 mm
Max. drill diameter with distance plates	1 000 mm
Max. drill bit length	980 mm

### Design

Steel dowel foot
Two-speed feed gearbox $i=1:2$ and $i=1:9$
Feed using hand crank
Can be adjusted to any angle
Adjusting feet (micro)

### Dimensions & Weight

Length	460 mm
Width	290 mm
Height	1 340 mm
Weight	30 kg

## System & Accessories

964906	ModulDrill™ distance plate $\varnothing +180$ mm
964907	ModulDrill™ distance plate $\varnothing +250$ mm
977464	ModulDrill™ mounting plate
974270	Extraction device for core bits
977353	Extraction device for cores
977462	Handwheel complete
974264	Trolley chassis
975746	Tool box
10991465	Water tank 10 l

## System suggestion

### Core drilling system BC-2

974266	Drill rig BC-2
984076	Fastening plate for ModulDrill™
10991100	Drill gearbox DGB1000
10998369	Drilling and circular wire saw kit WSE1621
10997955	Electric main drive motor WSE1621 400–480 V / 50 Hz
974263	Feed gear 2-speed
11002700	Electric control unit WSE1621 400 V   50 Hz incl. radio remote control
10987583	Feed motor
11002077	Fastening bolt assembly
11002624	Drill hammer DHE32 / 230 V incl. 16 mm drill



## Core drilling system BC-2 hydraulic

Core drilling up to Ø 1 000 mm

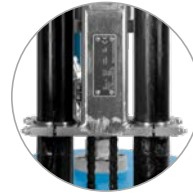

Gear reduction arms allow the drilling of bores up to 1 000 mm in diameter



Powerful drilling with hydraulic feed

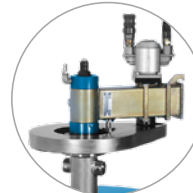

High stability yet low weight thanks to 2-pillar guide system

The BC-2 is ideal for drilling large holes up to 1 000 mm. Thanks to the modular design, combined use with TYROLIT cable saws and electric

equipment is possible without difficulty. The dual-column guidance principle and a two-speed feed gear enable user friendly work and low weight.

A large selection of drill accessories rounds off the range.

### Technical data

#### Drill rig BC-2

Drill diameter	100–350 mm
Max. drill diameter with 700 mm gear reduction arm	700 mm
Max. drill diameter with 1 000 mm gear reduction arm	1 000 mm
Max. drill bit length	830 mm

#### Design

Steel dowel foot
Two-speed feed gearbox $i=1:2$ and $1:9$

Feed using hand crank or hydraulic drive

Can be adjusted to any angle

Adjusting feet (micro)

#### Dimensions & Weight

Length	460 mm
Width	290 mm
Height	1 340 mm
Weight	30 kg



# System & Accessories



## Gear reduction arm

### Gear reduction arm module GR700

974283	Reduction ext. arm 700 mm i=1:11
976163	Motor complete B/S 30 ccm / FD

### Gear reduction arm module GR1000

974280	Reduction ext. arm 1 000 mm i=1:14
976163	Motor complete B/S 30 ccm / FD

### Accessories for gear reduction arm

974226	Extension GR 190 mm
974227	Extension GR 360 mm
974228	Extension GR 530 mm
977321	Large diameter flange
971294	GR-flange M30
10978286	GR-flange M30 with adapter 1 ¼"
974947	Adaptor BC 1 ¼" A
973925	Triplex chain for GR 1000
973926	Core catcher bush to GR

### Hydraulic motors for gear reduction arm

976160	Motor complete B/S 16 ccm / FD
976161	Motor complete B/S 18 ccm / FD
976162	Motor complete B/S 22 ccm / FD
976523	Motor complete B/S 26 ccm / FD
976163	Motor complete B/S 30 ccm / FD

## Accessories

977462	Handwheel complete
11002077	Fastening bolt assembly
11002624	Drill hammer DHE32 / 230 V incl. 16 mm drill
974947	Adaptor BC 1 ¼" A
974270	Extraction device for core bits
977353	Extraction device for cores
974264	Trolley chassis
975746	Tool box
10991465	Water tank 10 l

## Hydraulic drill motors (on drill spindle)

### With hydraulic feed

976156	Motor complete B 75 ccm / FD incl. PRV*
976157	Motor complete B 100 ccm / FD incl. PRV*
976032	Motor complete B 145 ccm / FD incl. PRV*
976033	Motor complete B 160 ccm / FD incl. PRV*

### With manual feed (with control valve)

976146	Motor unit B 60 ccm / FD incl. PRV*
976147	Motor unit B 75 ccm / FD incl. PRV*
976148	Motor unit B 100 ccm / FD incl. PRV*
976023	Motor unit B 145 ccm / FD incl. PRV*
976024	Motor unit B 160 ccm / FD incl. PRV*

## System suggestion

### Core drilling system BC-2, hydraulic

974266	Drill rig BC-2
976157	Motor complete B 100 ccm / FD incl. PRV*
974276	Drill spindle 1 ¼" complete incl. key
974210	Extension arm 350 mm
974240	Hydraulic feed kit
974263	Feed gear 2-speed
11002077	Fastening bolt assembly

\* PRV = Pressure control valve









# Wall sawing

<b>Information</b>	<b>100</b>
<b>Wall saw blades</b>	<b>102</b>
<b>Machines</b>	<b>110</b>



## Wall saw blades

Decades of experience in the production and application of wall saw blades and machines give TYROLIT the edge in the marketplace.

As a result our wall saw blades and machines can be viewed as innovative solutions for large-scale projects while remaining cost-effective for everyday construction site use. Particularly suitable for apertures and

openings in walls or ceilings as well as in reinforced or normal concrete with wall thicknesses up to 100 cm.

TYROLIT wall saw blades are designed to work flawlessly with TYROLIT Hydrostress machines. Wall sawing is a nearly vibration-free process that protects the material being cut.

## Application recommendation & information TYROLIT wall saw blades

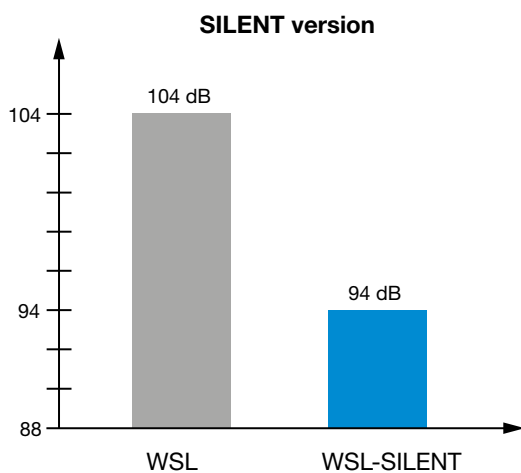

Reduction of the noise pressure level by 10 dB - this corresponds to half the noise level that is perceptible to humans.

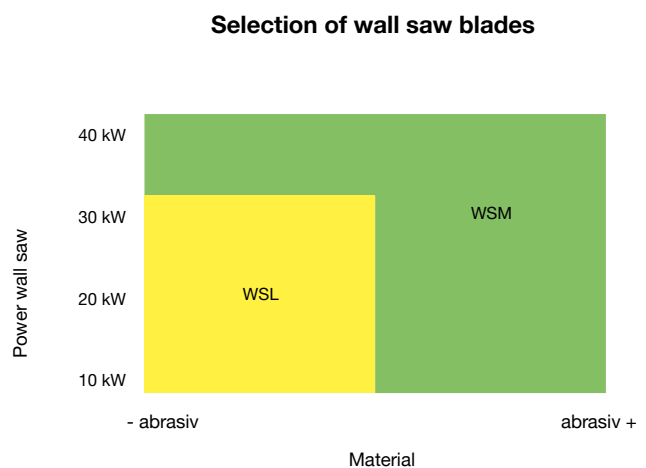

Selection of the correct wall saw blade according to the power class of the wall saw and the material to be processed.

### Recommendations

- + Highest levels of performance at peripheral speeds of 35–45 m/s on concrete
- + The correct coolant quantity is also important for optimum cutting performance
- + The machine safety and user instructions must be read and understood before starting work
- + The safety manual will be sent to you on request

### WSL-DEEP CUT Wall saw blades

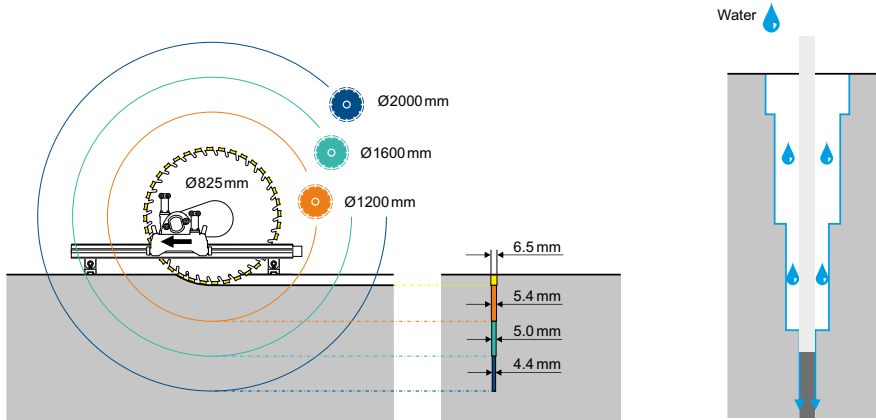

The WSL-DEEP CUT series: It provides wide segments at the beginning and can go blade wise narrower to the wanted cutting depth. This ensures a good opening on both sides of the steel core and for his reason the cooling water reaches the diamond segment in a good manner.

## Drive holes 12M255

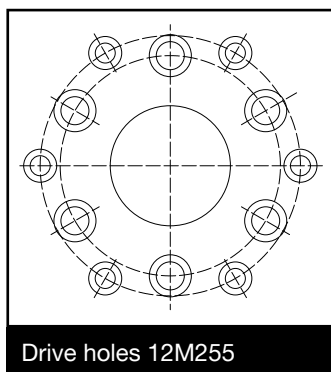

**Combination for TYROLIT wall saw heads**  
in Central Europe  
(except WSE811 MKII)  
**and HILTI / HUSQVARNA wall saw heads**

=

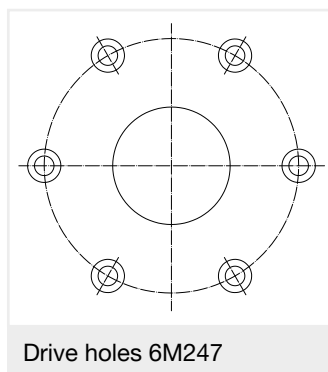

**For TYROLIT wall saw heads**  
in Central Europe  
(except WSE811 MKII)

**6M247 = 12M109**  
**without cooling drive holes**

+

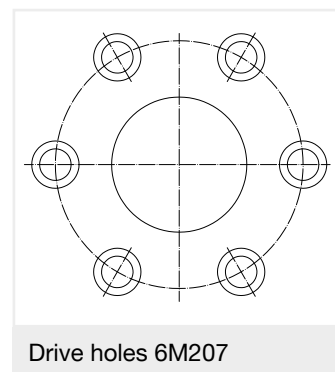

**For HILTI / HUSQVARNA wall saw heads**



## WSL-FAST CUT Wall saw blades

in TGD®-Technology

- + **Consistently very fast cutting performance and noticeable smooth running** with TGD®-Technology (TYROLIT GRAIN DISTRIBUTION), a unique technology developed by TYROLIT for the optimised distribution of grain.

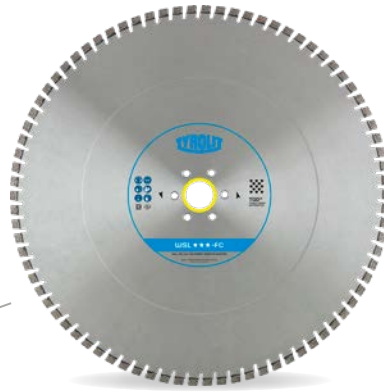

- + **Very long lifetime.**

Quality tools for the most demanding applications and maximum economic efficiency.

Laser welded segments for maximum safety.



### WSL-FAST CUT Wall saw blades in TGD®-Technology



	Shape	Type number	Dimension	Drive holes	Segment height
		C7W			
		34336798	600 × 4.9 × 60	6M199	13
		34497746	600 × 4.9 × 60	12M255	13
		34378038	650 × 4.4 × 60	6M199	13
		34549337	650 × 4.9 × 60	12M255	13
		34378037	750 × 4.4 × 60	6M199	13
		34478330	800 × 4.4 × 60	12M255	13
		34541416	800 × 4.9 × 60	12M255	13
		34377291	825 × 3.9 × 60	6M199	13
		34377152	825 × 4.4 × 60	6M199	13
		34475637	825 × 4.4 × 60	12M255	13
		34475635	825 × 4.9 × 60	12M255	13
		34549162	925 × 4.4 × 60	12M255	13
		34549338	925 × 4.9 × 60	12M255	13
		34479554	1000 × 4.4 × 60	12M255	13
		34475636	1025 × 4.4 × 60	12M255	13
		34496902	1025 × 4.9 × 60	12M255	13
34497747	1200 × 4.4 × 60	12M255	13		

6M199: for TYROLIT wall saw head WSE811 MKII

6M207: for HILTI/HUSQVARNA wall saw heads from 1998

12M109/6M247 without cooling drive holes: for all TYROLIT wall saw heads in Central Europe (except WSE811 MKII)

12M112: for all TYROLIT wall saw heads in Scandinavia (except WSE811 MKII)

12M255: Combination for TYROLIT wall saw heads in Central Europe (except WSE811 MKII) 12M109 without cooling drive holes and HILTI/HUSQVARNA wall saw heads 6M207 from 1998  
Turning holes for other machines available on request

● = low

● = medium







## WSL-FAST CUT-LONGLIFE Wall saw blades in TGD®-Technology

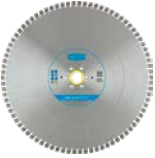

Quality tools for the most demanding applications and maximum economic efficiency.

Laser welded segments for maximum safety. Very long-living.



	Shape	Type number	Dimension	Drive holes	Segment height
	 C71W	34336749	600 × 3.9 × 60	6M199	13
		34549616	600 × 4.9 × 60	12M255	13
		34549620	650 × 4.9 × 60	12M255	13
		34475692	800 × 4.9 × 60	12M255	13
		34475693	825 × 4.4 × 60	12M255	13
		34493780	825 × 4.9 × 60	12M255	13
		34549618	925 × 4.4 × 60	12M255	13
		34475694	1025 × 4.4 × 60	12M255	13
		34493779	1025 × 4.9 × 60	12M255	13
		34549617	1200 × 4.4 × 60	12M255	13



## WSL Wall saw blades in TGD®-Technology

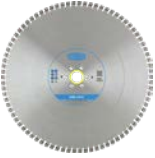

Quality tools for the most demanding applications and maximum economic efficiency. Laser welded segments for maximum safety.

	Shape	Type number	Dimension	Drive holes	Segment height
	 C71W	34018259	600 × 3.9 × 60	6M199	13
		34359375	600 × 3.9 × 60	12M255	13
		34018260	600 × 3.9 × 60	12M112	13
		34301250	600 × 4.4 × 60	12M255	13
		34018276	600 × 4.4 × 60	12M112	13
		34275378	600 × 4.9 × 60	12M255	13
		34018309	600 × 4.9 × 60	12M112	13
		34195250	650 × 3.9 × 60	6M199	13
		34195301	650 × 4.4 × 60	6M199	13
		34199529	650 × 4.9 × 60	12M255	13
		34549506	700 × 3.9 × 60	12M255	13
		34549509	750 × 3.9 × 60	12M255	13
		34018269	750 × 3.9 × 60	6M199	13
		34195304	750 × 4.4 × 60	6M199	13
		34359379	800 × 3.9 × 60	12M255	13
		34018272	800 × 3.9 × 60	12M112	13
		34254745	800 × 4.4 × 60	12M255	13
		34018280	800 × 4.4 × 60	12M112	13
		34018313	800 × 4.9 × 60	12M112	13
		34549511	825 × 3.9 × 60	12M255	13
		34208097	825 × 4.4 × 60	12M255	13
		34168251	825 × 4.9 × 60	12M255	13





### WSL Wall saw blades in TGD®-Technology



	Shape	Type number	Dimension	Drive holes	Segment height
		C71W			
		34549512	900 × 4.4 × 60	12M255	13
		34194330	900 × 4.9 × 60	12M255	13
		34254746	925 × 4.4 × 60	12M255	13
		34549515	925 × 4.9 × 60	12M255	13
		34018298	1000 × 4.4 × 60	12M112	13
		34232142	1025 × 4.4 × 60	12M255	13
		34430930	1025 × 4.9 × 60	12M255	13
		34018304	1200 × 4.4 × 60	12M112	13
34194331	1200 × 4.4 × 60	12M255	13		



### WSL-SILENT Wall saw blades in TGD®-Technology



Quality tools for the most demanding applications and maximum economic efficiency. Laser welded segments for maximum safety. Reduces noise by up to 10 dB.

	Shape	Type number	Dimension	Drive holes	Segment height
		C71GW			
		34018139	600 × 3.9 × 60	12M112	13
		34359351	600 × 4.4 × 60	6M247	13
		34018152	600 × 4.4 × 60	6M199	13
		34359353	600 × 4.9 × 60	6M247	13
		34018159	600 × 4.9 × 60	12M112	13
		34195471	650 × 4.4 × 60	6M199	13
		34549638	650 × 4.9 × 60	6M247	13
		34018166	700 × 4.4 × 60	12M112	13
		34195605	750 × 4.4 × 60	6M199	13
		34197742	800 × 4.4 × 60	6M207	13
		34359356	800 × 4.4 × 60	6M247	13
		34018170	800 × 4.4 × 60	12M112	13
		34359358	800 × 4.9 × 60	6M247	13
		34018174	800 × 4.9 × 60	12M112	13
		34040269	825 × 4.4 × 60	6M207	13
		34366463	825 × 4.4 × 60	6M247	13
		34444588	825 × 4.9 × 60	6M247	13
		34018177	1000 × 4.4 × 60	12M112	13
		34444590	1025 × 4.4 × 60	6M247	13
		34359373	1200 × 4.4 × 60	6M247	13
34018183	1200 × 4.4 × 60	12M112	13		

6M199: for TYROLIT wall saw head WSE811 MKII

6M207: for HILTI/HUSQVARNA wall saw heads from 1998

12M109/6M247 without cooling drive holes: for all TYROLIT wall saw heads in Central Europe (except WSE811 MKII)

12M112: for all TYROLIT wall saw heads in Scandinavia (except WSE811 MKII)

12M255: Combination for TYROLIT wall saw heads in Central Europe (except WSE811 MKII) 12M109 without cooling drive holes and HILTI/HUSQVARNA wall saw heads 6M207 from 1998  
Turning holes for other machines available on request

● = low



● = medium



## WSM Wall saw blades in TGD®-Technology

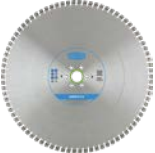

Quality tools for the most demanding applications and maximum economic efficiency. Laser welded segments for maximum safety.



	Shape	Type number	Dimension	Drive holes	Segment height
	 C71W	34549642	600 × 4.4 × 60	12M255	13
		34018208	600 × 4.4 × 60	12M112	13
		34549643	650 × 4.4 × 60	12M255	13
		34244855	650 × 4.9 × 60	12M255	13
		34018224	650 × 4.9 × 60	12M112	13
		34549644	700 × 4.4 × 60	12M255	13
		34018227	700 × 4.4 × 60	12M112	13
		34549645	750 × 4.4 × 60	12M255	13
		34018229	750 × 4.4 × 60	12M112	13
		34549646	800 × 4.4 × 60	12M255	13
		34018241	800 × 4.4 × 60	12M112	13
		34517568	800 × 4.9 × 60	12M255	13
		34018243	800 × 4.9 × 60	12M112	13
		34244861	825 × 4.4 × 60	12M255	13
		34244853	825 × 4.9 × 60	12M255	13
		34549648	925 × 4.4 × 60	12M255	13
		34549649	1000 × 4.4 × 60	12M255	13
		34018251	1000 × 4.4 × 60	12M112	13
		34244857	1025 × 4.4 × 60	12M255	13
		34549647	1025 × 4.9 × 60	12M255	13
34244856	1200 × 4.4 × 60	12M255	13		
34018255	1200 × 4.4 × 60	12M112	13		



## WSM-SILENT Wall saw blades in TGD®-Technology



Quality tools for the most demanding applications and maximum economic efficiency. Laser welded segments for maximum safety. Reduces noise by up to 10 dB.



	Shape	Type number	Dimension	Drive holes	Segment height
	 C71GW	34242048	600 × 4.4 × 60		13
		34419194	650 × 4.9 × 60		13
		34356569	700 × 4.4 × 60		13
		34549654	750 × 4.4 × 60	6M247	13
		34242053	800 × 4.4 × 60		13
		34475704	825 × 4.4 × 60	6M247	13
		34242054	1000 × 4.4 × 60		13
		34475705	1025 × 4.4 × 60	6M247	13



**WSL-FAST CUT-LONGLIFE-SILENT Wall saw blades**  
in TGD®-Technology



Quality tools for the most demanding applications and maximum economic efficiency. Laser welded segments for maximum safety. Very long-living. Reduces noise by up to 10 dB.



	Shape	Type number	Dimension	Drive holes	Segment height
	 C71	34549636	825 × 4.4 × 60	6M247	13
		34549635	825 × 4.9 × 60	6M247	13
		34549634	825 × 5.9 × 60	6M247	13
		34549398	1025 × 4.4 × 60	6M247	13
		34549637	1200 × 4.4 × 60	6M247	13



**WSL Wall saw blades**  
in TGD®-Technology



Quality tools for everyday use. An impressive cutting speed-lifetime ratio. Laser welded diamond segments using TGD®-Technology.



	Shape	Type number	Dimension	Drive holes	Segment height
	 C7W	34359385	600 × 3.9 × 60	12M255	13
		34017386	600 × 3.9 × 60	12M112	13
		34313605	600 × 4.4 × 60	12M255	13
		34017389	600 × 4.4 × 60	12M112	13
		34359386	600 × 4.9 × 60	12M255	13
		34017402	600 × 4.9 × 60	12M112	13
		34195305	650 × 3.9 × 60	6M199	13
		34195307	650 × 4.4 × 60	6M199	13
		34549400	650 × 4.9 × 60	12M255	13
		34359389	700 × 4.4 × 60	12M255	13
		34017404	750 × 3.9 × 60	6M199	13
		34195308	750 × 4.4 × 60	6M199	13
		34359391	800 × 4.4 × 60	12M255	13
		34017406	800 × 4.4 × 60	12M112	13
		34359392	800 × 4.9 × 60	12M255	13
		34542169	825 × 3.9 × 60	12M255	13
		34325781	825 × 4.4 × 60	12M255	13
		34017408	825 × 4.4 × 60	12M112	13
		34506340	825 × 4.9 × 60	12M255	13
		34359393	1000 × 4.4 × 60	12M255	13
		34017412	1000 × 4.4 × 60	12M112	13
		34444641	1025 × 4.4 × 60	12M255	13
		34017414	1025 × 4.4 × 60	12M112	13
		34359394	1200 × 4.4 × 60	12M255	13
		34017416	1200 × 4.4 × 60	12M112	13



## WSM Wall saw blades in TGD®-Technology



Quality tools for everyday use. An impressive cutting speed-lifetime ratio.  
Laser welded diamond segments using TGD®-Technology.

	Shape	Type number	Dimension	Drive holes	Segment height
	 C7W	34549420	600 × 4.4 × 60	12M255	13
		34017419	600 × 4.4 × 60	12M112	13
		34549421	650 × 4.9 × 60	12M255	13
		34549422	750 × 4.4 × 60	12M255	13
		34017424	750 × 4.4 × 60	12M112	13
		34017428	825 × 4.4 × 60	12M112	13
		34436519	825 × 4.4 × 60	12M255	13
		34475713	825 × 4.9 × 60	12M255	13
		34549423	925 × 4.4 × 60	12M255	13
		34549424	925 × 4.9 × 60	12M255	13
		34017433	1000 × 4.4 × 60	12M112	13
		34017435	1025 × 4.4 × 60	12M112	13
		34475714	1025 × 4.4 × 60	12M255	13
		34485561	1025 × 4.9 × 60	12M255	13
		34485500	1200 × 4.4 × 60	12M255	13
		34017438	1200 × 4.4 × 60	12M112	13

6M199: for TYROLIT wall saw head WSE811 MKII

6M207: for HILTI/HUSQVARNA wall saw heads from 1998

12M109/6M247 without cooling drive holes: for all TYROLIT wall saw heads in Central Europe (except WSE811 MKII)

12M112: for all TYROLIT wall saw heads in Scandinavia (except WSE811 MKII)

12M255: Combination for TYROLIT wall saw heads in Central Europe (except WSE811 MKII) 12M109 without cooling drive holes and HILTI/HUSQVARNA wall saw heads 6M207 from 1998

Turning holes for other machines available on request

● = low



● = medium



## WSL-DEEP CUT Wall saw blades in TGD®-Technology

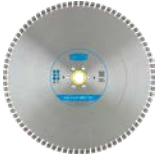

Quality tools for the most demanding applications and maximum economic efficiency.  
Up to 1 200 mm laser welded segments with TGD®-Technology.

	Shape	Type number	Dimension	Drive holes	Segment height	
		C7W	34549161	600 × 5.9 × 60	12M255	13
		34549167	750 × 6.5 × 60	12M255	13	
		34498693	800 × 5.9 × 60	12M255	13	
		34415642	825 × 5.9 × 60	12M255	13	
		34497741	825 × 6.5 × 60	12M255	13	
		34521389	1025 × 5.4 × 60	12M255	13	
		34422925	1200 × 4.9 × 60	12M255	13	
		34497743	1200 × 5.4 × 60	12M255	13	
		C4	34419445	1350 × 4.4 × 60	12M109	13
			34460891	1350 × 4.4 × 60	12M255	13
34415649	1400 × 4.4 × 60		12M255	13		
34401425	1400 × 4.4 × 60		12M109	13		
34399760	1500 × 4.4 × 60		6M225	13		
34379300	1500 × 4.4 × 60		12M109	13		
34488100	1500 × 4.4 × 60		12M255	13		
34488121	1600 × 4.4 × 60		12M255	13		
34409249	1600 × 4.4 × 60		6M225	13		
34379257	1600 × 4.4 × 60		12M109	13		
34497744	1600 × 5.0 × 60		12M255	13		
34450071	1600 × 5.0 × 60		12M109	13		
34450072	1600 × 5.6 × 60		12M109	13		
34500371	1600 × 5.6 × 60		12M255	13		
34379258	1800 × 4.4 × 60		12M109	13		
34488122	1800 × 4.4 × 60		12M255	13		
34379341	2000 × 4.4 × 60		12M109	13		
34497745	2000 × 4.4 × 60		12M255	13		
34379342	2200 × 4.4 × 60		12M109	13		
34500293	2200 × 4.4 × 60		12M255	13		

6M199: for TYROLIT wall saw head WSE811 MKII

6M207: for HILTI/HUSQVARNA wall saw heads from 1998

12M109/6M247 without cooling drive holes: for all TYROLIT wall saw heads in Central Europe (except WSE811 MKII)

12M112: for all TYROLIT wall saw heads in Scandinavia (except WSE811 MKII)

12M255: Combination for TYROLIT wall saw heads in Central Europe (except WSE811 MKII) 12M109 without cooling drive holes and HILTI/HUSQVARNA wall saw heads 6M207 from 1998  
Turning holes for other machines available on request

● = low

● = medium







# Compatibility overview

## Wall saws

Wall sawing



10990000  
Wall saw  
WSE1621

10986600  
Wall saw  
WSE2226

10984000  
Wall saw  
DZ-S2

10982000  
Wall saw  
WZ

999226  
Wall saw  
FZ-2ST

10997955	Electric main drive WSE1621	● **				
11002700	Electric control unit WSE1621	●				
10986800	Electric main drive WSE2226		●			
10986700	Electric control unit WSE2226		●			
10981719	Transport trolley	●	●			
10984099	Blade guard 800 mm 3 parts All-In-One	●	● **	●	●	●
10997700	Blade guard 800 mm 3 parts AIO Linear	●				
10984100	Blade guard 1 000 mm 3 parts All-In-One		● **	●	●	●
10999200	Blade guard 1 000 mm 3 parts AIO Linear	●				
10984101	Blade guard 1 200 mm 3 parts All-In-One	●	● **	●	●	●
10999400	Blade guard 1 200 mm 3 parts AIO Linear	●				
977606	Blade guard 1 600 mm 2 parts	●	●		●	●
976184	Blade guard 2 200 mm 2 parts		●			
10989200	Blade guard 1 200 mm All-In-One CL		●			
10982079	VAS G Track 1 100 mm   Alu	●	●	●	●	● *
10982105	VAS G Track 1 650 mm   Alu	●	●	●	●	● *
10982106	VAS G Track 1 925 mm   Alu	●	●	●	●	● *
10981818	VAS G Track 2 200 mm   Alu	●	●	●	●	● *
974398	V-Track VS 700 mm   Steel	●	●	●	●	●
974400	V-Track VS 1 100 mm   Steel	●	●	●	●	●
974402	V-Track VS 1400 mm   Steel	●	●	●	●	●
974404	V-Track VS 1 800 mm   Steel	●	●	●	●	●
974406	V-Track VS 2 200 mm   Steel					

\* up to max. 25 kW

\*\* mount with adapter



999039  
Wall saw  
FZ-4S



10998000  
Wire saw  
WCU17



10982500  
Circular wire saw  
CCE25



10994900  
Wire saw  
SB-E



10991100  
Modular drilling gearbox  
DGB1000 kpl

	999039 Wall saw FZ-4S	10998000 Wire saw WCU17	10982500 Circular wire saw CCE25	10994900 Wire saw SB-E	10991100 Modular drilling gearbox DGB1000 kpl
		●	●		●
		●	●		●
				●	
				●	
	●				
	●				
	●				
	●				
	●				
	●				
	●				
	●				
	●				
	●				

★★★  
PREMIUM



## Wall Saw WSE811 MKII

Cutting depths up to 335 mm

Wall sawing



Compact,  
fully integrated design

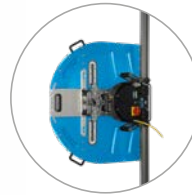

Light and sturdy:  
Tracks and blade guard



Handy radio remote control

The WSE811 MKII is the lightest wall saw in its power range in the world. Both installation and disassembly are realised in a glimpse thanks to its integrated design with only one cable and one hose. Combined with the perfected electronic feed control the impressive

power of the ultra-compact P2<sup>®</sup> motor delivers an unmatched cutting performance within the 16A range! Along with the new dedicated blade guard and sturdy and proven tracks the WSE811 MKII makes the dedicated gear for the vast majority of jobs with plenty of spare power.

# System & Accessories



## Technical data

Saw blade	
Max. cutting depth	335 mm
Max. saw blade Ø	825 mm
Free detachable up to Ø	700 mm
Blade flange mounting	Central screw
Saw blade fixing (flush cuts)	6 countersunk head screws, 90 mm graduated circle

## Electric motor and control unit

Water-cooled high-frequency motor	
Output on 16 A current supply	9 kW
Voltage	400 V
Frequency	50 Hz / 60 Hz

## Weight

Wall Saw WSE811 MKII	26 kg
Blade guard WSE811 MKII AIO 825	14 kg
Track EX 1100 mm	6.3 kg
Track EX 2200 mm	12.6 kg
Transport trolley WSE811 MKII	14.5 kg

## System & Accessories

Wall saw system WSE811 MKII	
10995000	Wall saw WSE811 MKII
10978640	Track EX 1 100 mm
10978879	Track EX 2 200 mm
10980156	Rotary rail support EX
10980156	Rotary rail support EX
10980156	Rotary rail support EX
10994800	Blade guard WSE811 MKII AIO 825 mm
10998781	Transport trolley WSE811

## Accessories

10980260	Track connector EX
10983408	Swivel-stairs track foot EX
10980264	Track stop EX

★★★  
PREMIUM



## Wall saw WSE1621

Cutting depths up to 705 mm



Tool-free motor fastening

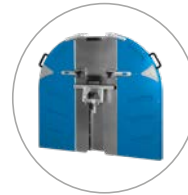

Light and sturdy:  
Blade guard



Compact and light control  
unit, handy remote control  
with display

The WSE1621 was developed for universal usage and the daily use on the construction site. Thanks to the digital features and the compact and light design, this newly developed system is setting new standards in wall sawing. Assembly and disassembly are done

in an instant thanks to the ultralight blade guard and the tool-free motor fastening. The radio remote control comes with a display informing the user about all important details during cutting. The game-changing P2® Technology allows for outstanding reliability

combined with optimized power. Apart from wall sawing, this wall saw's motor and control unit can also be used for wire sawing and drilling.



# System & Accessories

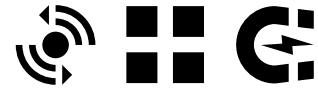

## Technical data

Saw blade	
Max. cutting depth	705 mm
Max. saw blade Ø	1 600 mm
Free detachable up to Ø	900 mm
Blade flange mounting	Quick-release flange
Saw blade fixing (flush cuts)	6 countersunk head screws, 130 mm graduated circle

## Electric motor

Water-cooled high-frequency motor	
Nominal power (32 A)	20 kW
Motor power S1 S1 (32 A)	17 kW
Voltage	400–480 V
Frequency	50 / 60 Hz

## Weight

Wall Saw WSE1621	23.5 kg
Electric main drive motor WSE1621	15 kg
Electric control unit WSE1621	16.5 kg
Radio remote control WSE1621	1.8 kg
Blade guard 1 000 mm AIO Linear	21.5 kg
Track VAS G 1 100 mm	9.4 kg
Track VAS G 1 650 mm	15 kg
Track VAS G 1 925 mm	16.2 kg
Track VAS G 2 200 mm	18.4 kg
Transport trolley WSE1621	21 kg

## System & Accessories

Wall saw system WSE1621	
10990000	Wall Saw WSE1621
10997955	Electric main drive motor WSE1621 400–480 V / 50 Hz
11002700	Electric control unit WSE1621 400–480 V / 50 Hz incl. radio remote control
10992200	Transport trolley WSE1621
10999200	Blade guard 1 000 mm AIO Linear
10982079	VAS G Track   1 100 mm   alu
10981818	VAS G Track   2 200 mm   alu
977523	Track connector for VAS- and VS-tracks
965987	V-Track feet alu, flat
965987	V-Track feet alu, flat
965987	V-Track feet alu, flat
10980346	Tool box

## Accessories

10997700	Blade guard 800 mm AIO Linear
10999400	Blade guard 1 200 mm AIO Linear
977606	Blade guard 1 600 mm 2 pcs.
10998282	Blade guard uptake 1 600 mm
10998500	Blade guard uptake AIO Ø800
11000361	Blade guard uptake AIO Ø1 000
10998285	Blade guard uptake AIO Ø1 200
10977882	Blade flange ST cpl.
961983	V-Swivel track feet
10977452	V-Rotary rail support compl.
10981719	Transport trolley small
10999403	Blade flange ST cpl. dry cutting

★★★  
PREMIUM

## Wall saw WSE2226

Cutting depths up to 1 005 mm



Optimum torque and rotational speeds thanks to the innovative drive concept with 2-speed transmission

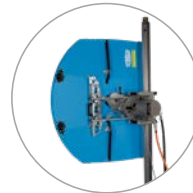

Extremely light and robust all-in-one blade guard for normal, corner and flush cutting



Cool water bypass for dry cutting

Developed for the toughest and most exacting applications thanks to a cutting depth of up to 1 005 mm, which is unique worldwide, the WSE2226 wall saw is particularly suitable for major cutting tasks. The pioneering P2® drive concept enables

the combination of extreme reliability and optimum performance with low service requirements and reduced service costs. The standard remote control enhances ease of use and safety in the workplace.

# System & Accessories



## Technical data

<b>Saw blade</b>	
Max. cutting depth	1 005 mm
Max. saw blade Ø	2 200 mm
Free detachable up to Ø	1 025 mm
Blade flange mounting	Quick-release flange
Saw blade fixing (flush cuts)	6 countersunk head screws, 130 mm graduated circle
<b>Electric motor</b>	
Water-cooled high-frequency motor	
Nominal power	26 kW
Motor power	22 kW
<b>Control unit</b>	
Voltage	400 V / 50 Hz
Frequency	50 Hz
Weight	26 kg
<b>Weight</b>	
Wall saw WSE2226 incl. feed motors	26 kg
Electric main drive motor WSE2226	25 kg
Blade guard 1 200 mm AIO CL	22 kg

## System & Accessories

<b>Wall saw system WSE2226</b>	
10986600	Wall saw WSE2226 incl. feed motors
10986800	Electric main drive motor WSE2226 400 V / 50 Hz
10986700	Electric control unit WSE2226 400 V / 50 Hz incl. radio remote control
10981719	Transport trolley
10989200	Blade guard 1 200 mm AIO CL
10982079	VAS G Track   1 100 mm   alu
10981818	VAS G Track   2 200 mm   alu
977523	Track connector for VAS and VS tracks
965987	V-Track feet alu, flat
965987	V-Track feet alu, flat
965987	V-Track feet alu, flat
10980346	Tool box
<b>Accessories</b>	
977523	Track connector for VAS and VS tracks
10977882	Blade flange ST compl.
10989200	Blade guard 1 200 mm AIO CL
10992730	Blade guard holder AIO/alu 2 pcs.
10984099	Blade guard 800 mm 3 pcs. AIO
10992724	Uptake AIO800 on WSE2226
10984100	Blade guard 1 000 mm 3 pcs. AIO
10992726	Uptake AIO1000 on WSE2226
10984101	Blade guard 1 200 mm 3 pcs. AIO
10992727	Uptake AIO1200 on WSE2226
977606	Blade guard 1 600 mm 2 pcs.
976184	Blade guard 2 200 mm 2 pcs.
10992734	Uptake 1 600/2 200 2 pcs. on WSE2226
965987	V-Track feet alu, flat
961983	V-Swivel track feet
10977452	V-Rotary rail support compl.

## Wall saw DZ-S2

Cutting depths up to 510 mm



Robust saw head with standard hydraulic motors



Blade guard for normal and flush cutting



Slide guide with ergonomic locking system and fine adjustment

The extremely sturdy and proven design ensures high reliability and cutting accuracy. With the DZ-S2 in conjunction with hydraulic drives with

outputs of up to 20 kW, blade diameters of up to maximum 1 200 mm can be used.

# System & Accessories

## Technical data

Saw blade	
Max. cutting depth	510 mm
Max. saw blade Ø	1 200 mm
Free detachable up to Ø	900 mm
Blade flange mounting	Central screw
Saw blade fixing (flush cuts)	6 countersunk head screws, 130 mm graduated circle

## Design

GR2 hydraulic motor with quick-change device	
Swivel arm, can be rotated by 360°	
Power transmission in swivel arm via toothed belt	
Carriage controlled using bronze guide	

## Weight

incl. drive motor and 2 feed motors	34 kg
with 2 feed motors only	27 kg

## System & Accessories

Wall saw system DZ-S2	
10984000	Wall saw DZ-S2 without motor
976162	Motor complete B/S 22 ccm / FD
10984100	Blade guard 1 000 mm 3 pcs. AIO
10982079	VAS G Track   1 100 mm   alu
10981818	VAS G Track   2 200 mm   alu
965987	V-Track feet alu, flat
965987	V-Track feet alu, flat
965987	V-Track feet alu, flat
975803	Tool box
977495	Pressure relief valve FD

## Accessories

973921	1 bronze guide complete
974419	Flush cutting flange DZ, FZ
969460	Tooth belt for DZ-S, DZ-S2
10984099	Blade guard 800 mm 3 pcs. AIO
10984100	Blade guard 1 000 mm 3 pcs. AIO
10984101	Blade guard 1 200 mm 3 pcs. AIO

## Hydraulic drive motor accessories – size 2 with horizontal FD couplings

976034	Motor complete B/S 12 ccm / FD
976160	Motor complete B/S 16 ccm / FD
976161	Motor complete B/S 18 ccm / FD
976162	Motor complete B/S 22 ccm / FD
976523	Motor complete B/S 26 ccm / FD
976163	Motor complete B/S 30 ccm / FD
973892	Quick-change set for motors size 2

# Wall saw FZ-4S

Cutting depths up to 1 005 mm

Wall sawing



Main motor with leak-oil connection



Gear swivel arm with quick-separation flange for easy blade replacement



Sliding systems with ergonomic locking system and fine adjustment

The "work horse" among hydraulic wall saws. Use of the quick-separation flange on the swivel arm provides simple, fast blade replacement and facilitates use in flush cutting

applications. With the FZ-4S in conjunction with hydraulic drives with outputs of up to 40 kW, blade diameters of up to maximum 2 200 mm can be used.



# System & Accessories

## Technical data

Saw blade	
Max. cutting depth	1 005 mm
Max. saw blade Ø	2 200 mm
Free detachable up to Ø	1 025 mm
Blade flange mounting	Quick-release flange
Saw blade fixing (flush cuts)	6 countersunk head screws, 130 mm graduated circle

## Design

GR3 hydraulic motor with quick change device (also possible with GR2)	
Swivel arm, can be rotated by 360°	
Power transmission in swivel arm via gear wheel	
Carriage controlled using Bronze Prisma	

## Weight

incl. drive motor and 2 feed motors	47 kg
with 2 feed motors only	39 kg

## System & Accessories

Wall saw system FZ-4S	
999039	Wall saw FZ-4S
976166	Motor complete S 31 ccm / FD, incl. leak oil conn.
10984100	Blade guard 1 000 mm 3 pcs. AIO
974400	V-Track VS 1 100 mm steel
974406	V-Track VS 2 200 mm steel
974478	V-Track foot steel DZ/FZ
974478	V-Track foot steel DZ/FZ
974478	V-Track foot steel DZ/FZ
974066	Leakage oil hose 8 m FIRG
977495	Pressure relief valve FD
10977020	Tool box

## Accessories

973921	1 bronze guide complete
10977882	Blade flange ST compl.
10984099	Blade guard 800 mm 3 pcs. AIO
10984100	Blade guard 1 000 mm 3 pcs. AIO
10984101	Blade guard 1 200 mm 3 pcs. AIO
977606	Blade guard 1 600 mm 2 pcs.
976184	Blade guard 2 200 mm 2 pcs.
977334	Blade guard holder 2 pcs. for bolt

## Hydraulic drive motors – size 3

976164	Motor complete S 20 ccm / FD, incl. leak oil conn.
976165	Motor complete S 25 ccm / FD, incl. leak oil conn.
976166	Motor complete S 31 ccm / FD, incl. leak oil conn.
976167	Motor complete S 40 ccm / FD, incl. leak oil conn.
974066	Leakage oil hose 8 m FIRG

## Rail system VAS and VS

Versatile; suitable for wall saws and line drills



### VAS

- + Lightweight aluminium rail suitable for applications up to 26 kW
- + Steel guides
- + Replaceable steel tothing
- + Extendable



### VS

- + Robust steel rail, suitable for applications up to 50 kW
- + Steel guides
- + Extendable



V-rotating rail trestle,  
can be swivelled by 360°  
10977452



V-swivel rail trestle, 45°–135°  
961983



V-rail trestle, aluminium, flat  
965987

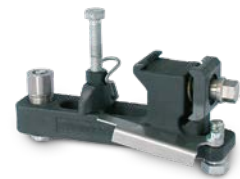

V-rail trestle, steel  
974478

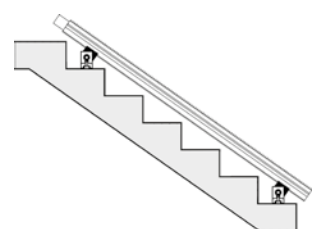
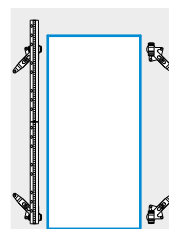
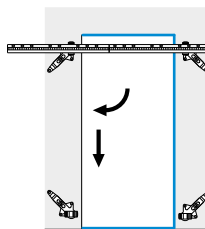
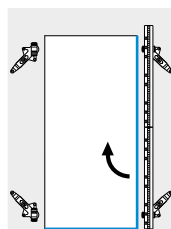
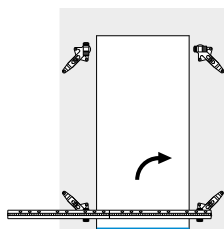

Time saved when changing the rail position thanks to innovative V-rotating rail support

With V rotating rail support,  
simple step sawing

# System & Accessories



## Technical data

	VAS	VS
Approved power	25 kW	50 kW
Weight at 1 100 mm	9.3 kg	13.8 kg
Material	Aluminium/ steel	Steel
Extendable	•	•
Length	1 100 mm	700 mm
	1 650 mm	1 100 mm
	1 925 mm	1 400 mm
	2 200 mm	1 800 mm
		2 200 mm

## Compatible wall saws

WSE1621 / WSE2226	•	•
DZ-S2	•	•
WZ	•	•
FZ-2ST	•	•
FZ-4S		•

## Rail trestles

V-rail trestle, steel		•
V-rail trestle, aluminium	•	•
V-swivel rail trestle	•	•
V-rotating rail trestle	•	•



Well thought-out connecting elements for quick assembly and a rigid connection



Rail stopper for safe working

## System & Accessories

### VAS rail system

10982079	VAS G Track   1 100 mm   alu
10982105	VAS G Track   1 650 mm   alu
10982106	VAS G Track   1 925 mm   alu
10981818	VAS G Track   2 200 mm   alu

### VAS accessories

965987	V-Track feet alu, flat
961983	V-Swivel track feet
10977452	V-rotary rail support complete
977523	Track connector for VAS and VS tracks
963917	Centering tube for VAS/VS tracks
10978418	Track stop for VAS track
974476	Mounting block for track foot, vacuum base (concrete)
977452	Mounting block for track foot, vacuum base (masonry)
10978418	Track stop

### VS rail system

974398	V-Track VS   700 mm   steel
974400	V-Track VS   1 100 mm   steel
974402	V-Track VS   1 400 mm   steel
974404	V-Track VS   1 800 mm   steel
974406	V-Track VS   2 200 mm   steel

### VS accessories

974478	V-Track foot steel
961983	V-Swivel track feet
10977452	V-rotary rail support complete
977523	Track connector for VAS and VS tracks
10978418	Track stop





HYDROSTRESS





# Wire sawing

<b>Information</b>	<b>126</b>
<b>Diamond saw wires</b>	<b>128</b>
<b>Accessories</b>	<b>130</b>
<b>Machines</b>	<b>134</b>



## Diamond wire saw

Decades of experience in the production and application of diamond wires and wire saw machines give TYROLIT the edge in the marketplace.

Suitable for clearance and demolition work, dismantling bridges, buildings and numerous other large-scale reinforced concrete structures. Virtually

unaffected by wall thicknesses and steel content. Perfect in combination with TYROLIT Hydrostress machines.



# Application recommendation

## Choosing the correct diamond wire

Performance Level	Type	Bead		Machine			Concrete aggregate material				Level of reinforcement			Dry cutting
		Sintered	Electro-plated	L	M	H	Soft	Medium	Hard	Very hard	Low	Very high	100 %	
★★★ PREMIUM	DWM-C		x	●	●	●	●	●	●	●	○	○	○	○
	DWL-CF	x		●	●	○	●	○	○	○	○	○		
	DWM-S		x	●	●	●	○	○	○	○	●	●	●	○
	DWH-S   S-ATEX		x	●	●		●	●	●	●	●	●	●	○
★★ STANDARD	DWM-C		x	●	●	○		○	○	○	○	○	○	○
★ BASIC	DWM-C		x	●	●	○		○	○	○	○	○	○	○

Machine			Material		Suitability	
<b>Power</b>			<b>Aggregates</b>		Optimal	●
Low	L	≤15 kW	Very hard	Flinz	Good	●
Medium	M	15–25 kW	Hard	Quartz	Acceptable	○
High	H	25–50 kW	Medium	Granite	Not suitable	
			Soft	Limestone		

## Service

- + Can be supplied with locking mechanism attached on request
- + Can be delivered in unbroken lengths of up to 100 m
- + Technical support provided by our trained staff

## Information / Recommendations

- + Optimum application conditions / wire speed

<b>Concrete</b>	soft aggregates with little reinforcement	21–25 m/s
<b>Concrete</b>	hard aggregates with high reinforcement	16–21 m/s
<b>Steel</b>	100 %	10–18 m/s

- + Assemble the locking mechanisms according to the regulations
- + Use only original TYROLIT accessories
- + Caution: Do not use shears for cutting. Use an angle grinder with a thin cut-off wheel
- + The safety and operating instructions sent with the machine must be observed at all times when using diamond saw wires. The safety manual will be sent to you on request

Wire sawing



# DWH-S ATEX Saw wire

Electroplated | for steel

+ **Very fast cutting performance, very long lifetime and noticeable smooth running**  
due to special, optimised bead assembly and high bead count.



+ **High level of safety**  
due to robust construction.

Wall sawing



## DWH-S ATEX Saw wire

Electroplated | for steel



For the most demanding applications and solutions for complex projects. The colour yellow has been chosen for better visibility during underwater use.

The diamond wire is also available in a split version (SL) for certain lengths.

	Type number	Diameter	Beads / m
	34053745	11.0	46



## DWH-S | SL Saw wire

Electroplated | for steel



For the most demanding applications and solutions for complex projects. The colour yellow has been chosen for better visibility during underwater use.

	Type number	Diameter	Beads / m
	34380722	11.0	46



## DWM-S | SL Saw wire

Electroplated | for steel



For the most demanding applications and solutions for complex projects. The diamond wire is also available in a split version for certain lengths.

	Type number	Diameter	Beads / m
	603261	10.2	46



**DWM-C Saw wire**  
Electroplated | for concrete

For everyday use.  
Cost-effective solution for standard applications.



Type number	Diameter	Beads / m
572996	10.2	46
34425148	8.5	46



**DWL-CF Saw wire**  
Sintered | for concrete

For the most demanding applications and solutions for complex projects.



Type number	Diameter	Beads / m
34425149	10.7	40



**DWM-C Saw wire**  
Electroplated | for concrete

For everyday use.  
Cost-effective solution for standard applications.



Type number	Diameter	Beads / m
34425078	10	40

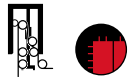

**DWM-C Saw wire**  
Electroplated | for concrete

For everyday use.  
Cost-effective solution for standard applications.



Type number	Diameter	Beads / m
34410842	10	40

## Saw wire accessories



Hydraulic hand press 80 kN for optimum connection of diamond wires,  
incl. 1 set of press inserts for hand press TN 578301.

	Type number	Diameter
	SPV 117984	80kN-KPL

## Saw wire accessories



Press inserts for hydraulic hand press 80 kN (TN 117984).

	Type number	Saw wire diameter
	SPEV 524002	8
	578301	10.2 / 11

## Saw wire accessories





Cardanic sleeve and spare bolts for saw wire diameters 10–11.3 mm.

	Type number	Saw wire diameter
	SVG 218909	10–11.3
	SVGB 218914	

## Saw wire accessories



Repair sleeve for saw wire diameters 8.5–11.3 mm.

		Type number	Saw wire diameter
	SVR	902134	8.5
		600045	10–11.3
			

## Saw wire accessories



Assembly fixture for cardanic sleeve and spare pin.

		Type number	Comment
	SMGV	860404	II Assembly fixture
		148130	2.5 Spare bolt

## Saw wire accessories



A60S-BFP | 2in1 Cut-off wheel for cutting the wire.

		Type number	Dimension
	41	34332754	125 × 1.0 × 22.23

# Compatibility overview

## Wire saws

Wall sawing



10998000  
Wire saw  
WCU17



10982500  
Circular wire saw  
CC25



10994900  
Wire saw  
SB-E



10990000  
Wall saw  
WSE1621



10986600  
Wall saw  
WSE2226



10991100 Modular  
drilling gearbox  
DGB1000 kpl

10997955 Electric main drive WSE1621	●	●		●		●
11002700 Electric control unit WSE1621	●	●		●		●
10986800 Electric main drive WSE2226			●		●	
10986700 Electric control unit WSE2226			●		●	
10988900 Electric main drive WSE1217	●	●				●
10989300 Electric control unit WSE1217	●	●				●



# Wire saw accessories

## Plunge tube

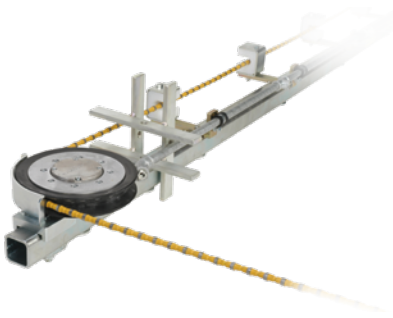

Equipment for cutting a cube out of concrete foundations

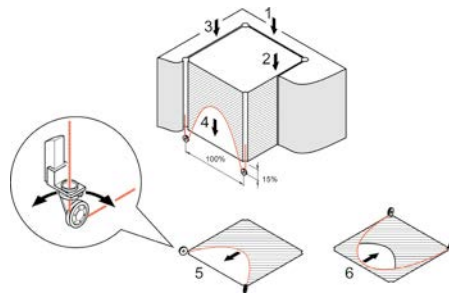

Immersion wire saw procedure for horizontal and vertical cutting. Cutting depths up to 2.5 m

## Diverter rolls for wire guidance

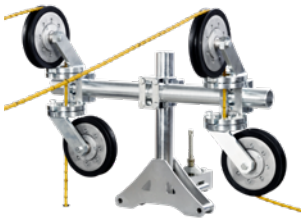

Universal support: Wire can be diverted in any direction



Plug roll: For hole Ø 62 mm, slot allows insertion of closed wire loops



Diverter roll: Wire diversion with one adjustable axis



Support roll: Eliminates sagging wire and reduces vibration

### Plunge tube

964256	Plunge wire sawing assembly right side
964253	Plunge wire sawing assembly left side
977099	Base swivel pulley for plunge tube (left)
10982439	Base swivel pulley for plunge tube (right)

### Diverter rolls

980712	Frame short
10990900	Universal pulley frame
10994985	Plug roll cpl.
980713	Swivel pulley for universal pulley frame
964254	Pulley Ø 200 mm
964419	Pulley Ø 200 mm with hole Ø 13 mm
980714	Individual pulley Ø 200 mm with clamp
980706	2 support pulleys with holder

★★★  
PREMIUM

## Wire saw WCU17

Gross wire length 17 m

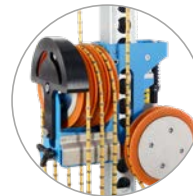

Greatly simplified handling of the wire storage

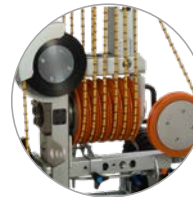

Easy starting thanks to multiple pulley drive



Assembled in no time: ergonomic, compact and weight-optimised main components

The wire saw with the extra large wire storage and long stroke for maximum utilisation and application for a maximum structure size of 12.6 m. Very finely adjustable feed with wire-conserving smooth starting

for optimal control of the application, also thanks to the innovative damping system. The saw, consisting of only three ergonomically optimised main components, is assembled within a minute and can be placed directly on

the object to be cut. Wire guidance is intuitive and simple. The expandable modular system can be driven both electrically as well as hydraulically by means of add-on kits.

# System & Accessories



## Technical data

Wire	
Wire storage	12.6 m
Overall wire length	17 m
Wire Ø, sintered	11 mm
Wire Ø, galvanised	10 mm

## Design

6 drive rolls Ø 200 mm
Diverter rolls Ø 200 mm

## Dimensions & Weight wire saw

Height	1 600 mm
Width	750 mm
Depth	500 mm
Weight without cover	86 kg
Weight with cover	98 kg

## System & Accessories

Wire saw system WCU17 / WSE1621	
10998000	Wire saw WCU17 (incl. wire protection)
11000004	Motor mounting kit WSE1621
10997955	Electric main drive WSE1621 400–480 V / 50 Hz
11002700	Electric control unit WSE1621 400–480 V / 50 Hz incl. radio remote control

## Accessories

11000004	Motor mounting kit WSE1621
10997000	Motor mounting kit WSE1217
10997100	Motor mounting kit hydraulic (max. 25 kW)
10999257	Template WCU17
10999322	Water lance 8 m Geka
973892	Quick-change set for motors size 2
976161	Motor complete B/S 18 ccm / FD
976162	Motor complete B/S 22 ccm / FD
976163	Motor complete B/S 30 ccm / FD
10999820	Rubber lining Ø 200 PUR 70
10997222	Pulley Ø 200 Standard
977954	Protective sleeve

★★★  
PREMIUM

## Wire saw WCE18

Gross wire length 19 m

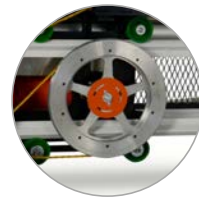

High start-up torque and power transfer with minimal slippage due to the large drive wheel.



Reduced load on main components due to reduced-pressure wire storage.



Clear, user-friendly control panel.

The wire saw has 15 m of wire storage and a powerful 18 kW high-performance drive for tough jobs in high-performance sectors such as controlled dismantling of large buildings.

The continuously variable wire speed from 0-25 m/s and the precisely adjustable tensile force – thanks to pneumatic wire tension – help provide maximum cutting performance.

# System & Accessories

## Technical data

### Wire

Wire storage	15 m
Gross wire length	19 m
Wire Ø	8-12 mm

### Design

High-frequency electric motor 18 kW
1 large drive roller Ø 445 mm
Pulleys Ø 280 mm
Continuously variable and controllable wire speed
Feed is pneumatic due to a compressor (accessories)

### Electric motor

Water-cooled high-frequency motor	
Output at 32 A	18.5 kW

### Monitoring

Voltage	380-400 V
Frequency	50 Hz / 60 Hz

### Wire saw dimensions & weight

Height	1 170 mm
Width	1 810 mm
Depth	760 mm
Weight	354 kg

### Control dimensions & weight

Height	1 240 mm
Width	730 mm
Depth	750 mm
Weight	113 kg

## System & Accessories

### Wire saw WCE18

10999800	Wire saw WCE18
----------	----------------

### Accessories

11001135	Pneumatic compressor 6 l / 8 bar
----------	----------------------------------

★★★  
PREMIUM

## Wire saw WCE30

Gross wire length 30 m

Wall sawing



Optimal start-up torque and power transfer with minimal slippage due to 2 large drive wheels.



Chassis made from stainless steel.



Clear, user-friendly control panel.

25 m wire storage and a double-motor high-frequency drive with 37 kW make child's play of decommissioning even large structures like bridges, chimneys and foundations. The continuously

variable wire speed from 0-25 m/s and the precisely adjustable tensile force thanks to pneumatic wire tension help provide optimal cutting performance.



# System & Accessories

## Technical data

### Wire

Wire storage	25 m
Gross wire length	30.1 m
Wire Ø	8-12 mm

### Design

Double high-frequency electric motor 37 kW
2 large drive rollers Ø 445 mm
Pulleys and storage rolls Ø 280 mm
Continuously variable and controllable wire speed from 0-25 m/s
Feed is pneumatic due to a compressor (accessories)

### Electric motor

2 water-cooled high-frequency motors	
Output at 32 A	37 kW

### Control

Voltage	380-400 V
Frequency	50 Hz / 60 Hz

### Wire saw dimensions & weight

Height	1290 mm
Width	2300 mm
Depth	740 mm
Weight	544 kg

### Control dimensions & weight

Height	1240 mm
Width	610 mm
Depth	370 mm
Weight	113 kg

## System & Accessories

### Wire saw WCE30

10999700	Wire saw WCE30
----------	----------------

### Accessories

11001135	Pneumatic compressor 6 l / 8 bar
----------	----------------------------------

★★★  
PREMIUM

## Wire saw SB ATEX | SB-E

Gross wire length 15.5 m

Wall sawing



Efficient power transmission through multi-pulley drive



Quiet running because of hydraulic wire tensioner



Size of wire storage can be decreased or increased in a glimpse

The wire saw with plenty of wire storage packed within a compact and mobile casing featuring a powerful multiple pulley transmission. The SB

can be driven by hydraulic power packs as well as by the modular WSE2226 system with its striking 26 kW drive motor.

# System & Accessories

## Technical data

<b>Wire</b>	
Wire storage capacity	10 m
Gross wire length	15 m
Wire Ø, sintered	11 mm
Wire Ø, galvanic	10 mm

## Design

Size 3 hydraulic motor or electric motor 26 kW
7 drive pulleys Ø 200 mm (180)
Diverter pulleys Ø 200 mm (180)
Wire fed to wire storage using hydraulic cylinder

## Dimensions & Weight

Height	1 310 mm
Width	735 mm
Depth	750 mm
Weight	170 kg

## Electric motor

Water-cooled high-frequency motor	
Output at 32 A	17 kW
Output at 63 A	26 kW
Weight	25 kg

## Control unit electric motor

Voltage	400 V
Frequency	50/60 Hz
Weight	26 kg

## Feed unit SB-E

Voltage	400 V
Frequency	50/60 Hz
Output at 63 A	18 kW
Rotational speed control via frequency converter	

## Dimensions & Weight

Height	510 mm
Width	390 mm
Depth	670 mm
Weight	32 kg

## System & Accessories

<b>Wire saw system SB</b>	
961946	Wire saw SB
976165	Motor complete S 25 ccm / FD, incl. leak oil conn.

## Wire saw system SB-E

10994900	Feed unit SB-E
961946	Wire saw SB
10986800	Electric main drive motor WSE2226P 400 V / 50 Hz
10986700	Electric control unit WSE2226P 400 V / 50 Hz incl. radio remote control

## Accessories

976166	Motor complete S 31 ccm / FD, incl. leak oil conn.
976167	Motor complete S 40 ccm / FD, incl. leak oil conn.
976168	Motor complete S 50 ccm / FD, incl. leak oil conn.
961902	Pulley Ø 200 mm with hole Ø 13 mm (75 Shore)
961901	Diverter pulley Ø 200 mm
10999820	Rubber lining Ø 200 PUR 70
977083	Water lance 2,5 m
977613	Protective sleeve cpl.
10988618	Water lance 8 m
974066	Leakage oil hose 8 m FIRG
10996200	Motor mounting kit WSE2226 -> SB

★★★  
PREMIUM

## Circular wire saw CCH25 | CCE25

Circular cuts of  $\varnothing$  500–2 500 mm



Standard hydraulic drive motor



Wire can be easily inserted and tensioned



Flexible water supply

As part of the modular TYROLIT systems, the circular wire saw can be driven either hydraulically (CCH25) or electrically (CCE25). The covered wire

guide ensures safe application and the well-thought-out design ensures simple handling.

# System & Accessories

## Technical data

### Wire

Wire length for hole diameter 500 mm (100 mm thickness)	4 m
Wire length for hole diameter 2,500 mm (600 mm thickness)	6.2 m
Wire Ø, sintered	11 mm
Wire Ø, galvanic	10 mm

### Hydraulic version

Hydraulic motor GR2
1 drive roll Ø 200 mm
Diverter rolls Ø 200 mm
Wire fed from wire store hydraulically

### Electric version

1 drive roll Ø 200 mm (180)
Diverter rolls Ø 200 mm (180)
Wire fed from wire store electrically

### Electric motor

Nominal power (32 A)	20 kW
Motor power S1 (32 A)	17 kW

### Control

Voltage	400–480 V
Frequency	50/60 Hz
Weight	22 kg

### Weight

Electric main drive motor WSE1621	14.3 kg
Electric control unit WSE1621	10.9 kg
Circular wire saw basic machine	122 kg

## System & Accessories

### Wire saw system CCH25

967610	Circular wire saw base machine
980759	Feed motor hydraulic 50 ccm
976160	Motor complete B/S 16 ccm / FD
973892	Quick-change set for motors size 2

### Wire saw system CCE25

10990500	Circular wire saw CCE25
11000348	Drilling and circular wire saw kit WSE1621 Universal
10997955	Electric main drive motor WSE1621 400–480 V / 50 Hz
11002700	Electric control unit WSE1621 400–480 V / 50 Hz incl. remote control

### Accessories

964887	Center tube SL adjustment
978788	Cantilever pipe, short (up to Ø 1.25 m)
978764	Cantilever pipe, long (up to Ø 2.5 m)
978786	Splash protection channel (Ø 2.5 m)
978787	Splash protection channel (Ø 1.25 m)
977083	Water lance 2.5 m
964254	Pulley Ø 200 mm
969413	Drive wheel SL Ø 200 mm
10999820	Rubber lining Ø 200 PUR 70







# Floor sawing

<b>Information</b>	<b>146</b>
<b>Floor saw blades</b>	<b>148</b>
For cured concrete	148
For asphalt	152
For green concrete	155
<b>Machines</b>	<b>160</b>









## Floor saw blades

Decades of experience in the production and application of floor saws and machines give TYROLIT the edge in the marketplace. As a result, our products can be seen as innovative solutions for large-scale projects while remaining cost-effective for everyday construction site use.

TYROLIT floor saw blades are designed to work perfectly with TYROLIT Hydrostress machines as well as all common floor saws.

- + Exceptional and consistent cutting performance coupled with a long service life
- + Universal use
- + Innovative diamond segment design
- + Quiet when working on reinforced concrete
- + Clean cutting edges
- + Large product range: diameters from 300–1 200 mm in various segment widths

### Colour indication

	Concrete	Asphalt
Low Power ( $\leq 15$ kW)		
Medium Power ( $> 15$ – $25$ kW)		
High Power		
Extreme high Power		

# Application recommendation

## Choosing the correct floor saw blade

Performance Level	Type	Machine		Material								
		Shaft-drive		Cured concrete				Green concrete			Asphalt	
		B/D	EL/HYD	Very hard	Hard	Medium	Soft	Very hard	Hard	Medium/Soft	Hard	Medium/Soft
★★★ PREMIUM	FSA	L	L							○	○	●
	FSM-A	M/H	M							⦿	●	⦿
	FSH-A	H/X	H							○	●	○
	FSC	L	L	○	⦿	●	●					
	FSL-C	L/M	L	○	●	●	⦿					
	FSM-C	M/H	M	○	⦿	●	●					
	FSH-C	H/X	H	●	●	●	⦿					
	FSH-CX	H/X	H	●	●	●	⦿					
	FSX-C3	H/X	H/X	●	●	●	⦿					
	FSL-G3	L	L					●	⦿	○		○
	FSL-G4	M	L/M					●	⦿	○		○
	FSM-G3	M/H	L/M					⦿	●	●	○	⦿
	FSM-G4	M/H	M/H					●	●	⦿	○	⦿
	FSM-G5	H/X	H/X					⦿	●	⦿	⦿	⦿
	FSH-G3	H	X					○	⦿	●	⦿	●
FSA+C	L	L			○	○		○	○	○	●	
★★ STANDARD	FSL-A	L/M	L							○	⦿	●
★ BASIC	FSA	L	L				○			○	○	●
	FSU	L	L	○	⦿	●	●					

Machine				Material		Suitability	
Power	Type	Power	Shaft-drive	Aggregates	Aggregates	Suitability	Suitability
Low	L	≤15 kW	EL	Electric	Very hard	Flint	Optimal ●
Medium	M	15–25 kW	HYD	Hydraulic	Hard	Quartz	Good ⦿
High	H	25–50 kW	B*	Petrol	Medium	Granite	Acceptable ○
Very high	X	>50 kW	D*	Diesel	Soft	Limestone	Not suitable

\* with V-belt drive

### Service

- + Bores and drive holes for special machines are available on request
- + Larger diameters are available on request

### Information / Recommendations

- + Optimum application conditions / peripheral speed
 

Material	Peripheral speed
Asphalt	55–60 m/s
Cured concrete (soft aggregates with little reinforcement)	40–50 m/s
Cured concrete (hard aggregates)	35–45 m/s
Green concrete	50–55 m/s
- + The safety and operating instructions sent with the machine must be observed at all times when using floor saws. The safety manual will be sent to you on request.



# FSX-C3 Floor saw blade

for cured concrete | in TGD®-Technology

+ **Consistently very fast cutting performance and noticeable smooth running**  
with TGD®-Technology (TYROLIT GRAIN DISTRIBUTION), a unique technology developed by TYROLIT for the optimised distribution of grain.



+ **Very long lifetime.**

Machines from 50 kW / hydr. >75 kW Universal | soft to very hard concrete aggregates. Details: Laser welded up to a diameter of 1 200 mm.

Special segment shape with a protective function to guard against premature steel blade wear in the contact zone – (undercutting-effect).



## FSX-C3 Floor saw blade for cured concrete | in TGD®-Technology



	Shape	Type number	Dimension	Driving bore	Segment height
		C37W			
		34349099	450 × 5 × 35/25,4	7M174	14
		34190381	500 × 3,9 × 25,4		14
		34212466	500 × 4,4 × 25,4		14
		34212475	600 × 3,9 × 25,4		14
		34212464	600 × 3,9 × 35/25,4	7M174	14
		34212468	600 × 4,4 × 25,4		14
		34075027	600 × 4,4 × 35/25,4	7M174	14
		34190384	650 × 3,9 × 25,4		14
		34212469	650 × 4,4 × 25,4		14
		34071124	650 × 4,4 × 35/25,4	7M174	14
		34212490	750 × 3,9 × 25,4		14
		34212481	750 × 4,4 × 25,4		14
		34075029	750 × 4,4 × 35/25,4	7M174	14
		34376610	800 × 4,4 × 25,4		14
34212482	900 × 4,4 × 25,4		14		

7M174: Cedima/Lissmac: 6 bores with 14 mm diameter on 120 mm pitch circle plus 1 bore 11.5 mm on 57.4 mm pitch circle  
7M23: Wakra: 6 bores with 7.4 mm diameter on 92 mm pitch circle plus 1 bore 11.5 mm on 57.4 mm pitch circle

● = low    ● = medium    ● = high    ● = extreme high power





	Shape	Type number	Dimension	Driving bore	Segment height
	C37W	34075041	900 × 4.4 × 35/25.4	7M174	14
		34311460	1000 × 4.4 × 25.4		14
		34297545	1000 × 4.4 × 35/25.4	7M174	14
		34297602	1200 × 4.4 × 25.4		14
		34295503	1200 × 4.4 × 35/25.4	7M174	14



**FSL-C Floor saw blade**  
for cured concrete | in TGD®-Technology



Machines up to 15 kW | soft to very hard aggregates. Details: Laser welded up to a diameter of 1 200 mm. Special segment shape with a protective function to guard against premature steel blade wear in the contact zone – (undercutting-effect).



	Shape	Type number	Dimension	Driving bore	Segment height
		620570	350 × 3.2 × 25.4		10
		620571	350 × 3.9 × 25.4		10
		612893	450 × 3.9 × 25.4		10
		613264	450 × 4.4 × 25.4		10
		613271	500 × 3.9 × 25.4		10
		613272	600 × 3.9 × 25.4		10
		638179	600 × 3.9 × 25.4	7M23	10
		648205	600 × 3.9 × 60/25.4		10
		613273	600 × 4.4 × 25.4		10
		615335	600 × 5 × 25.4		10
		103020	650 × 3.9 × 25.4		10
		613274	700 × 3.9 × 25.4		10
		615338	700 × 4.4 × 25.4		10
		613276	800 × 3.9 × 25.4		10
		615339	800 × 4.4 × 25.4		10
		615340	900 × 4.4 × 25.4		10
		615341	1000 × 4.4 × 25.4		10
		646183	1200 × 4.4 × 35/25.4	7M174	10



**FSM-C Floor saw blade | Cured concrete**  
for cured concrete | in TGD®-Technology



Machines up to 25 kW | hydraulic drives up to 50 kW | soft to very hard aggregates. Details: Laser welded up to a diameter of 1 200 mm. Special segment shape with a protective function to guard against premature steel blade wear in the contact zone – (undercutting-effect).



	Shape	Type number	Dimension	Driving bore	Segment height
		620572	350 × 3.2 × 25.4		10
		620573	350 × 3.9 × 25.4		10
		739750	350 × 3.9 × 35/25.4	7M174	10
		615342	450 × 3.9 × 25.4		10
		653498	450 × 3.9 × 35/25.4	7M174	10





**FSM-C Floor saw blade**  
for cured concrete | in TGD®-Technology



	Shape	Type number	Dimension	Driving bore	Segment height
		C77W			
		613277	450 × 5 × 25.4		10
		631830	450 × 5 × 35/25.4	7M174	10
		613280	500 × 3.9 × 25.4		10
		613284	600 × 3.9 × 25.4		10
		613285	600 × 4.4 × 25.4		10
		613286	600 × 5 × 25.4		10
		624783	600 × 5 × 35/25.4	7M174	10
		613287	700 × 3.9 × 25.4		10
		615343	700 × 4.4 × 25.4		10
		643676	700 × 4.4 × 35/25.4	7M174	10
		613288	800 × 4.4 × 25.4		10
		621887	800 × 4.4 × 35/25.4	7M174	10
		34167502	800 × 5 × 25.4		10
		613289	900 × 4.4 × 25.4		10
		613291	1000 × 4.4 × 25.4		10
633953	1000 × 4.4 × 35/25.4	7M174	10		
620575	1200 × 4.4 × 25.4		10		





**FSH-C Floor saw blade**  
for cured concrete | in TGD®-Technology



Machines up to 50 kW / hydr. >50 kW Universal | soft to very hard concrete aggregates. Details: Laser welded up to a diameter of 1 200 mm.

Special segment shape with a protective function to guard against premature steel blade wear in the contact zone – (undercutting-effect).

	Shape	Type number	Dimension	Driving bore	Segment height
		C77W			
		34434020	350 × 3.9 × 35/25.4	7M174	10
		34156477	450 × 3.9 × 25.4		10
		34291445	450 × 3.9 × 35/25.4	7M174	10
		34433996	450 × 5 × 35/25.4	7M174	10
		34156478	500 × 3.9 × 25.4		10
		34201330	600 × 3.9 × 25.4		10
		34239567	600 × 4.4 × 25.4		10
		34174307	600 × 4.4 × 35/25.4	7M174	10
		34238987	600 × 5 × 25.4		10
		34433997	700 × 4.4 × 25.4		10
		34210621	700 × 4.4 × 35/25.4	7M174	10
		34234940	800 × 4.4 × 25.4		10
		34174303	800 × 4.4 × 35/25.4	7M174	10
		34476019	800 × 5 × 25.4		10
		34238986	900 × 4.4 × 35/25.4	7M174	10
		34235444	1000 × 4.4 × 25.4		10
		34321445	1000 × 4.4 × 35/25.4	7M174	10
		34295499	1200 × 4.4 × 35/25.4	7M174	10

7M174: Cedima/Lissmac: 6 bores with 14 mm diameter on 120 mm pitch circle plus 1 bore 11.5 mm on 57.4 mm pitch circle  
7M23: Wakra: 6 bores with 7.4 mm diameter on 92 mm pitch circle plus 1 bore 11.5 mm on 57.4 mm pitch circle

● = low      ● = medium      ● = high      ● = extreme high power



★★★ PREMIUM **FSH-CX Floor saw blade**  
for cured concrete | in TGD®-Technology



Machines up to 50 kW / hydr. >50 kW Universal | soft to very hard concrete aggregates. Details: Laser welded up to a diameter of 1 200 mm.

Special segment shape with a protective function to guard against premature steel blade wear in the contact zone – (undercutting-effect).

	Shape	Type number	Dimension	Driving bore	Segment height	
		C77W	34490794	350 × 3.9 × 25.4		10
		34543798	450 × 3.9 × 25.3		10	
		34415340	500 × 3.9 × 25.4		10	
		34398707	500 × 4.4 × 25.4		10	
		34415411	600 × 3.9 × 25.4		10	
		34518415	600 × 4.4 × 35/25.4	7M174	10	
		34415417	600 × 4.4 × 25.4		10	
		34543799	600 × 5 × 25.5		10	
		34539240	600 × 5.4 × 25.4		10	
		34415412	650 × 3.9 × 25.4		10	
		34530761	650 × 4.4 × 35/25.4	7M174	10	
		34415418	650 × 4.4 × 25.4		10	
		34438342	750 × 4.4 × 25.4		10	
		34518417	750 × 4.4 × 35/25.4	7M174	10	
		34535827	800 × 4.4 × 35/25.4	7M174	10	
		34464256	800 × 4.4 × 25.4		10	
		34438343	900 × 4.4 × 25.4		10	
		34530763	900 × 4.4 × 35/25.4	7M174	10	
		34538573	900 × 5 × 25.4		10	
		34499425	1000 × 4.4 × 35/25.4	7M174	10	
34543797	1200 × 4.4 × 35/25.4	7M174	10			
34538575	1200 × 5 × 25.4		10			

★★★ PREMIUM **FSC Floor saw blade**  
for cured concrete



Machines up to 15 kW | soft to medium-hard aggregates. Details: Laser welded up to a diameter of 600 mm. Equipped with measuring bore for easy wear control of the segment height.

A 35–25.4 mm reduction bush is supplied for saw blades with a 35 mm bore.

	Shape	Type No.	Dimension	Segment height	
		C7W	574853	300 × 3.2 × 25.4	12
		574854	350 × 3.2 × 25.4	12	
		574855	400 × 3.2 × 25.4	12	
		574856	450 × 3.6 × 25.4	12	
		574857	500 × 3.6 × 25.4	12	
		574858	600 × 3.6 × 25.4	12	
		34237521	700 × 3.6 × 35/25.4	12	
		34237523	800 × 3.9 × 35/25.4	12	

Floor sawing



# FSL-A Floor saw blade

for asphalt



+ **Consistently fast cutting performance, long lifetime** using wide spacing.

+ **Inclined protective segments** to guard against premature steel blade wear in the contact zone – (undercutting-effect).

Machines up to 25 kW | soft to very hard aggregates. Details: Laser-welded up to a diameter of 800 mm. With protective segments to guard against premature steel blade wear in the contact zone – (undercutting-effect).

A 35–25.4 mm reduction bush is supplied for saw blades with a 35 mm bore. Suitable for renovation, controlled demolition and demolition of roads, highways, airports, bridges and industrial buildings. Also for removing

damaged concrete ceilings and for ceiling breakthroughs up to a thickness of 50 cm. An extremely fast cutting feed, a very long service life and a low cutting pressure, which protects the machine, characterize the tools.



## FSL-A Floor saw blade for asphalt



	Shape	Type number	Dimension	Segment height	
		C7SW	620541	350 × 3.2 × 25.4	11
		620542	400 × 3.2 × 25.4	11	
		620544	450 × 3.6 × 25.4	11	
		621163	450 × 5 × 35/25.4	11	
		599004	500 × 3.6 × 25.4	11	
		620558	600 × 3.6 × 25.4	11	
		621164	600 × 5 × 35/25.4	11	
		34237486	700 × 4.7 × 35/25.4	11	
		34237487	800 × 4.7 × 35/25.4	11	
				C1S	620553
620555	1000 × 4.7 × 35/25.4			11	
620556	1200 × 4.7 × 35/25.4			11	

7M174: Cedima/Lissmac: 6 bores with 14 mm diameter on 120 mm pitch circle plus 1 bore 11.5 mm on 57.4 mm pitch circle

7M23: Wakra: 6 bores with 7.4 mm diameter on 92 mm pitch circle plus 1 bore 11.5 mm on 57.4 mm pitch circle

● = low      ● = medium      ● = high



**FSM-A Floor saw blade for asphalt**



Machines up to 50 kW | hard to very hard aggregates. Details: Laser-welded up to a diameter of 600 mm. With protective segments to guard against premature steel blade wear in

the contact zone – (undercutting-effect). A 35–25.4 mm reduction bush is supplied for saw blades with a 35 mm bore.

	Shape	Type number	Dimension	Segment height	
		C3SW	620533	350 × 3.2 × 25.4	9
		620536	400 × 3.2 × 35/25.4	9	
		620532	450 × 3.6 × 25.4	9	
		621191	450 × 5 × 25.4	9	
		589737	500 × 3.6 × 25.4	9	
		589734	600 × 3.6 × 25.4	9	
		620528	600 × 4.7 × 25.4	9	
		621192	600 × 5 × 25.4	9	
		C3S	620529	700 × 4.7 × 35/25.4	9
		620530	800 × 4.7 × 35/25.4	9	
		620531	900 × 4.7 × 35/25.4	9	



**FSH-A Floor saw blade for asphalt**



Machines over 50 kW | hard to very hard abrasive aggregates. Details: Laser-welded up to a diameter of 600 mm. With protective segments to guard against premature steel blade wear in



the contact zone – (undercutting-effect). A 35–25.4 mm reduction bush is supplied for saw blades with a 35 mm bore.

	Shape	Type number	Dimension	Segment height	
		C3SW	620559	350 × 3.2 × 25.4	9
		620561	400 × 3.2 × 25.4	9	
		620563	450 × 3.6 × 25.4	9	
		621193	450 × 5 × 25.4	9	
		620564	500 × 3.6 × 25.4	9	
		620565	600 × 4.7 × 25.4	9	
			C3S	620567	700 × 4.7 × 35/25.4
	620568		800 × 4.7 × 35/25.4	9	
	620569		900 × 4.7 × 35/25.4	9	

★★★ PREMIUM  **FSA Floor saw blade for asphalt**  



Machines up to 15 kW | soft to very hard aggregates. Details: laser welded up to a diameter of 800 mm. with protective segments to guard against premature steel blade wear in the contact zone – (undercutting-effect) and

measuring bore for easy wear control of the segment height. A 35–25.4 mm reduction bush is supplied for saw blades with a 35 mm bore.

	Shape	Type number	Dimension	Segment height	
		C7SW	574838	300×3.2×25.4	9
		574844	350×3.2×25.4	9	
		574845	400×3.2×25.4	9	
		574846	450×3.6×25.4	9	
		574848	500×3.6×25.4	9	
		574850	600×3.6×25.4	9	
		34237480	700×4.2×35/25.4	9	
		34237482	800×4.2×35/25.4	9	

★ BASIC  **FSA Floor saw blade for asphalt**  



Materials able to be machined: Asphalt, sandstone, extremely abrasive materials. Details: Protective segments against the undercutting-effect.

	Shape	Type number	Dimension	Segment height	
		C1SW	34546444	450×3.6×25.4	10
		34573482	500×3.6×25.4	10	

★★★ PREMIUM  **FSA+C Floor saw blade for asphalt & concrete**   



Machinable materials: asphalt, green concrete with soft to hard material aggregates and a small amount of cured concrete. Details: Protective

segments against the undercutting-effect.

	Shape	Type number	Dimension	Segment height	
		C7SW	34527692	450×3.6×25.4	10
		34573481	500×3.6×25.4	10	

★ BASIC  **FSU Floor saw blade for universal building materials**  

Materials able to be machined: Universal building materials, such as concrete, clay brick, natural stone, etc.

	Shape	Type number	Dimension	Segment height	
		C3W	34546443	450×3.6×25.4	10
		34573300	500×3.6×25.4	10	

7M174: Cedima/Lissmac: 6 bores with 14 mm diameter on 120 mm pitch circle plus 1 bore 11.5 mm on 57.4 mm pitch circle  
 7M23: Wakra: 6 bores with 7.4 mm diameter on 92 mm pitch circle plus 1 bore 11.5 mm on 57.4 mm pitch circle

● = low      ● = medium      ● = high



# FSM-G4 Floor saw blade

for green concrete



+ **Reduced cutting pressure**  
very clean groove edges,  
cuts extremely quickly.

+ **Inclined protective segments**  
to guard against premature steel blade wear in the contact zone – (undercutting-effect).

Expansion joints, factory floors.  
Machines up to 25 kW / hydr. up to 50 kW Universal | soft to very hard concrete aggregates. Details: All diameters are laser-welded.

Equipped with a protective segment to guard against steel core wear in the contact zone –(undercutting effect). Very clean groove edges, cuts extremely quickly.

Floor sawing



## FSM-G4 Floor saw blade for green concrete





	Shape	Type number	Dimension	Segment height	
		C73SW	34015812	300 × 2.4 × 25.4	13
			151540	350 × 2.8 × 25.4	13



**FSL-G4 Floor saw blade for green concrete**



Expansion joints, factory floors. Machines up to 15 kW | very hard concrete aggregates. Details: All diameters are laser-welded. Equipped with a protective segment to guard against steel core wear in the contact zone – (undercutting effect). Very clean groove edges, cuts extremely quickly.



	Shape	Type number	Dimension	Segment height
		C73SW 151571	300 × 2.4 × 25.4	13
		34015787	350 × 2.8 × 25.4	13



**FSL-G3 Floor saw blade for green concrete**



Expansion joints / expansion grooves, road construction. Machines up to 15 kW Universal | soft to very hard concrete aggregates. Details: All diameters are laser welded. Equipped with a protective segment to guard against steel core wear in the contact zone – (undercutting effect). Very clean groove edges, cuts extremely quickly.



	Shape	Type number	Dimension	Driving bore	Segment height
		C73SW 34015785	350 × 2.8 × 25.4		13
		34157335	350 × 2.8 × 35/25.4	7M174	13
		34015786	400 × 3.2 × 35/25.4		13



**FSM-G3 Floor saw blade for green concrete**



Expansion joints / expansion grooves, road construction. Machines up to 50 kW / hydr. >50 kW Universal | soft to very hard concrete aggregates. Details: All diameters are laser-welded. Equipped with a protective segment to guard against steel core wear in the contact zone – (undercutting effect). Very clean groove edges, cuts extremely quickly.

	Shape	Type number	Dimension	Driving bore	Segment height
		C73SW 34015788	300 × 3.9 × 25.4		13
		34170349	300 × 3.9 × 35/25.4	7M174	13
		34015790	350 × 2.8 × 25.4		13
		34071635	350 × 2.8 × 35/25.4	7M174	13
		34015791	350 × 3.2 × 35/25.4	7M174	13
		34015793	350 × 3.9 × 35/25.4	7M174	13
		34165029	350 × 5 × 35/25.4	7M174	13
	34015794	400 × 3.2 × 35/25.4	7M174	13	
	34015797	450 × 3.6 × 35/25.4	7M174	13	
		C3SW 34015798	500 × 3.6 × 35/25.4	7M174	13
		34015799	600 × 3.6 × 35/25.4	7M174	13

7M174: Cedima/Lissmac: 6 bores with 14 mm diameter on 120 mm pitch circle plus 1 bore 11.5 mm on 57.4 mm pitch circle

7M23: Wakra: 6 bores with 7.4 mm diameter on 92 mm pitch circle plus 1 bore 11.5 mm on 57.4 mm pitch circle

● = low      ● = medium      ● = high      ● = extreme high power



★★★ PREMIUM **FSM-G5 Floor saw blade**  
for green concrete



Expansion joints / expansion grooves, road construction. Machines up to 50 kW / hydr. >50 kW Universal | soft to very hard concrete aggregates. Details: All diameters are laser-welded.

Equipped with a protective segment to guard against steel core wear in the contact zone – (undercutting effect.) Very clean groove edges, cuts extremely quickly.

	Shape	Type number	Dimension	Driving bore	Segment height
		C73SW 34015813	350 × 2.8 × 35/25.4	7M174	13
		34015815	350 × 3.2 × 35/25.4	7M174	13
		151353	350 × 3.9 × 35/25.4	7M174	13
		34015816	350 × 5 × 35/25.4	7M174	13
		151359	400 × 3.2 × 35/25.4	7M174	13
		34359295	400 × 3.9 × 35/25.4	7M174	13
		151376	450 × 3.6 × 35/25.4	7M174	13
	C3SW	34015817	500 × 3.6 × 35/25.4	7M174	13
		34015818	600 × 3.6 × 35/25.4	7M174	13

★★★ PREMIUM **Floor saw blade**  
Chamfer cutter for green concrete



H3092B50 | 90° two parts | for groove widths from 8 mm.

	Type number	Dimension	Segment height	Running direction
	FRSU-5784A 642857	280 × 10 × 25.4	3	right
	34575156	280 × 10 × 25.4	3	left

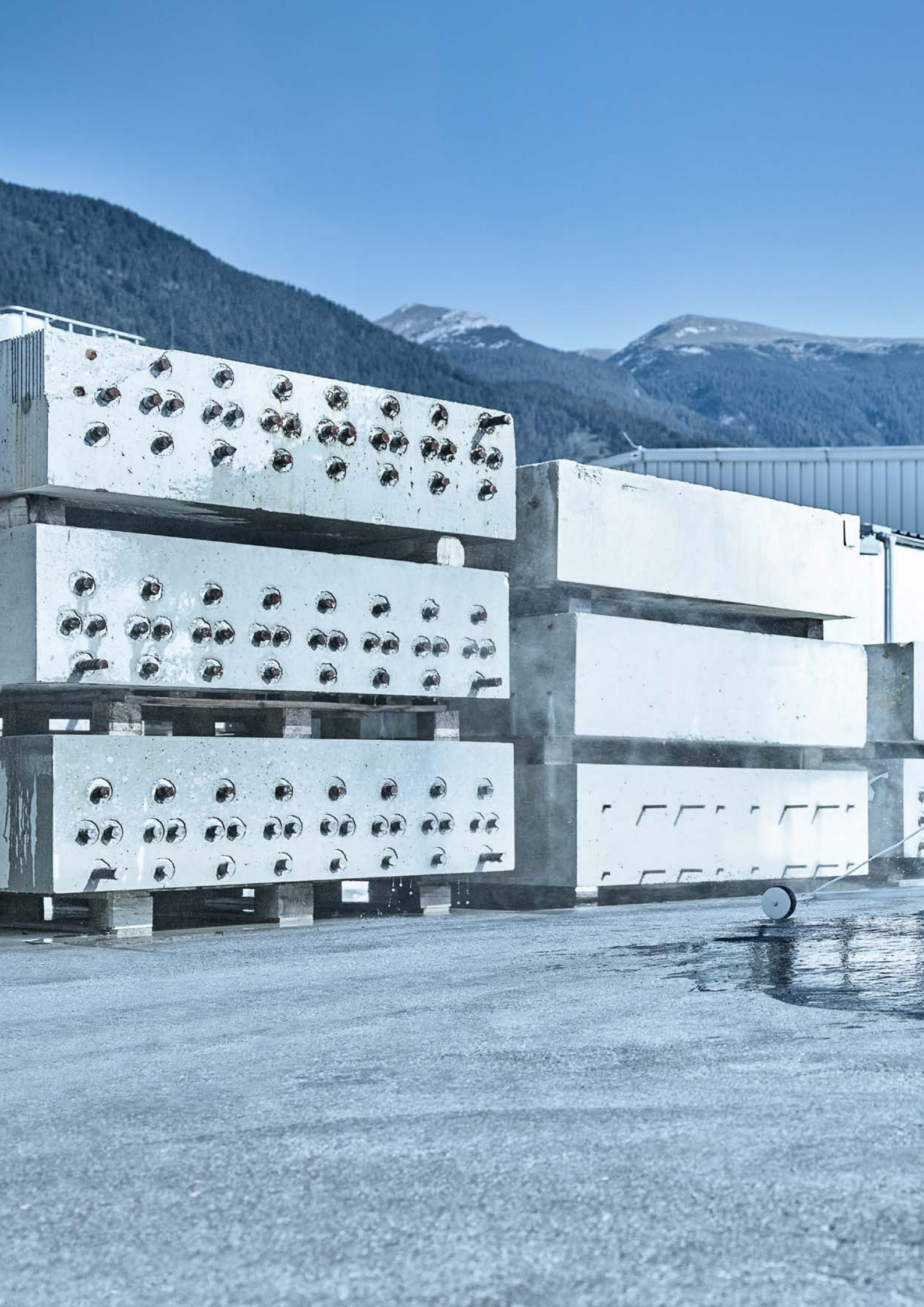





★★★  
PREMIUM

## Floor saw FSG513

Cutting depth up to 195 mm



User-friendly cutting depth setting and convenient speed control



Optimised centre of gravity above the shaft



Universal field of application with left and right cutting function

Thanks to its extremely robust, high-quality chassis, the FSG513 is highly robust and flexible thanks to the left- and right-handed as well

as corner flush cutting functions. The reliable Honda petrol engine is equipped with a cyclone air filter.

# System & Accessories

## Saw blade

Saw blade	
Max. cutting depth	195 mm
Max. saw blade Ø	500 mm
Saw blade speed	2 600 rpm
Saw blade uptake Ø	25.4 mm
Carrier Ø	11.5 mm
Reference circle Ø	57.4 mm

## Drive

Drive / motor	Petrol
Type	Honda
Power	8.2 kW / 11 HP
Fuel	Lead free
Fuel tank	6.1 l
Engine cooling	Air cooling
Feed	Manual
Blade drive	Via V-belt

## Design

Manual, cutting depth adjustment via spindle
Cutting depth indicator
Tool cooling using water fork
Left and right hand cutting function
Flush corner cut function
25 l water tank

## Dimensions & Weight

Length	1 136 mm
Width	578 mm
Height	1 016 mm
Weight	115 kg

## System & Accessories

Floor saw FSG513	
10988800	Floor saw FSG513 incl. water tank kit
Accessories	
11004545	Operating hours counter (Feed kit)



★★  
STANDARD

## Floor saw FSG620

Cutting depth up to 230 mm



Exceptionally easy handling due to neatly arranged control panel



Controlled work thanks to digital operating hours counter and reliable petrol gauge



Blade guard side change in just a few steps

Thanks to its intelligent weight distribution, the FSG620 provides for excellent cutting behaviour and the left- and right-handed cutting function enhances flexibility.



# System & Accessories

## Saw blade

Saw blade	
Max. cutting depth	230 mm
Max. saw blade Ø	600 mm
Saw blade speed	2 120 rpm
Saw blade holder Ø	25.4 mm
Carrier Ø	11.5 mm
Reference circle Ø	57.4 mm

## Drive

Drive / motor	Petrol
Type	Honda
Output	13 kW / 18 PS
Fuel	Lead free
Fuel tank	7.6 l
Engine cooling	Air cooling
Feed	Hydraulic
Blade drive	Via V-belt
Feed speed	0–24 m/min

## Design

Manual, stepless cut depth setting via a spindle
Tool cooling using water fork
Left / right cutting function
25 l water tank

## Dimensions & Weight

Length	840 mm
Width	580 mm
Height	1 030 mm
Weight	184 kg

## System & Accessories

Floor saw FSG620	
10984041	Floor saw FSG620
Accessories	
10984389	Green concrete kit with 350 mm blade guard and transformation set (3 000 rpm)

★★★  
PREMIUM

## Floor saw FSE811

Cutting depth up to 320 mm



Transmission guarantees optimum cutting speeds



Left and right cutting



Maintenance free belt drive

Perfectly suited for indoor use, the floor saw FSE811 has also been especially designed for locations that are difficult to access and allows a quick and easy change from left to

right cutting. Additionally, this saw features a smooth cutting depth adjustment using a precise and protected spindle.

# System & Accessories

## Saw blade

Saw blade	
Max. cutting depth	320 mm
Max. saw blade Ø	800 mm
Saw blade speed	1 250 rpm
Saw blade holder Ø	25.4 mm
Carrier Ø	11.5 mm
Reference circle Ø	57.4 mm

## Drive

Drive / motor	Electric
Output	7.5 kW
Voltage / frequency	400 V / 50 Hz
Engine cooling	Air cooling
Feed	Manual
Blade drive	Via V-belt

## Design

Manual, cutting depth adjustment via spindle
Cutting depth indicator
Tool cooling using function
Left / right cutting function
Corner flush cutting function

## Dimensions & Weight

Length	1 100 mm
Width	600 mm
Height	980 mm
Weight	158 kg

## System & Accessories

Floor saw FSE811	
10992000	Floor saw FSE811

★★  
STANDARD

## Floor saw FSD930

Cutting depth up to 350 mm



Easy, controlled work thanks to clear control panel



Water regulation for optimum tool cooling and useful lighting always within reach



Exact alignment of the machine using cut indicator

Thanks to intelligent weight distribution, the FSD930 features excellent cutting behaviour. The hydraulic feed drive and electro-hydraulic cutting depth adjustment permit convenient and ergonomic operation.

# System & Accessories

## Saw blade

Saw blade	
Max. cutting depth	350 mm
Max. saw blade Ø	900 mm
Saw blade speed	1 400 rpm
Saw blade holder Ø	25.4 mm
Carrier Ø	11.5 mm
Reference circle Ø	57.4 mm

## Drive

Drive / motor	Diesel
Type	Deutz
Output	22 kW / 30 PS
Fuel	Diesel
Fuel tank	22.8 l
Engine cooling	Air cooling
Feed	Manual
Blade drive	Via V-belt
Feed speed	0–61 m/min

## Design

Electric-hydraulic cutting depth adjustment
Cutting depth indicator
Tool cooling using water fork
Left / right cutting function
Corner flush cutting function

## Dimensions & Weight

Length	1 170 mm
Width	820 mm
Height	1 250 mm
Weight	655 kg

## System & Accessories

Floor saw FSD930	
10984042	Floor saw FSD930

## Accessories

10984390	Green concrete kit with 450 mm blade guard and transformation set (2 300 rpm)
----------	---

*Diesel particle filter and transformation set on request*

★★★  
PREMIUM

## Floor saw FSE1022

Cutting depth up to 420 mm



Floor sawing



Particularly compact design



Clear and ergonomically arranged control panel

The robust, powerful floor saw FSE1022 was specially developed for cutting tasks in buildings. The frequency converter enables the continuously variable adjustment of the cutting shaft speed, making it

possible to set the optimum cutting speed for every saw blade diameter. The low centre of gravity and precise distribution of weight on the axes ensure stability and excellent directional stability.



# System & Accessories

## Technical data

Saw blade	
Max. cutting depth	420 mm
Max. saw blade Ø	1,000 mm
Saw blade speed	850 rpm – 1,850 rpm
Saw blade holder Ø	25.4 mm
Carrier Ø	11.5 mm
Reference circle Ø	57.4 mm

## Drive

Drive / motor	Electric motor
Output	22 kW
Voltage / frequency	400 V/32 A
Engine cooling	Air
Feed	Electric
Blade drive	Via V-belt

## Design

Left / right cutting function
Cutting depth indicator
Corner flush cutting function
Electro-hydraulic cutting depth adjustment

## Dimensions & weight

Length	1,150 mm
Width	795 mm
Height	1,350 mm
Weight	388 kg

## System & Accessories

Floor saw FSE1022	
11002122	Floor saw FSE1022
11002123	Flush cut blade guard 800 mm

★★★  
PREMIUM

## Floor saw FSD1049 3-Speeds

Cutting depth up to 430 mm



Floor sawing



Three-speed transmission for optimum blade speeds



Easy handling and work monitoring due to neatly arranged control panel

The FSD1049 features a 3-speed transmission for optimum blade speeds and diamond tool lifetime. The raising/lowering system as well as simple, continuously variable

cutting depth adjustment operate hydraulically. The smallest and most powerful floor saw in this power range.

# System & Accessories

## Saw blade

Saw blade	
Max. cutting depth	430 mm
Max. saw blade Ø	1 000 mm
No Load saw blade speed	2 700/1 800/1 200 1/min
Saw blade holder	25.4 mm
Carrier	11.5 mm
Reference circle	57.4 mm

## Drive

Drive / motor	Diesel
Type	Deutz
Output	36.5 kW / 49 PS
Fuel	Diesel
Fuel tank	34.2 l
Engine cooling	Air
Feed	Hydrostatic
Blade drive	Via V-belt
Feed speed	0–61 m/min

## Design

Electro-hydraulic cutting depth adjustment
Cutting depth indicator
Tool cooling using water fork
Left / right cutting function
3 speed gearbox

## Dimensions & Weight

Length	1 450 mm
Width	980 mm
Height	1 250 mm
Weight	775 kg

## System & Accessories

Floor saw FSD1049	
10986900	Floor Saw FSD1049 3 Speed (1 000 mm guard)

## Accessories

10991715	350 mm (14") blade guard
10989833	500 mm (20") blade guard
10985254	650 mm (26") blade guard
10989836	750 mm (30") blade guard
10989838	900 mm (36") blade guard

*Diesel particle filter and transformation set on request*

★★  
STANDARD

## Floor saw FSE1240

Cutting depth up to 480 mm



Suitable for construction site use, intelligent design with protected electronic components



Constant control and monitoring possibility thanks to precise displays



Easy handling due to logically arranged control panel

Thanks to intelligent weight distribution, the FSE1240 features excellent cutting behaviour. The hydraulic feed drive and electro-hydraulic cutting depth adjustment ensure convenient

and ergonomic operation. Increased flexibility using left- and right-handed cutting function and corner cutting function.

# System & Accessories

## Saw blade

Saw blade	
Max. cutting depth	480 mm
Max. saw blade Ø	1 200 mm
Saw blade speed	1 075 rpm
Saw blade holder Ø	25.4 mm
Carrier Ø	11.5 mm
Reference circle Ø	57.4 mm

## Drive

Drive / motor	Electric
Output	30 kW
Voltage / frequency	400 V / 50 Hz
Engine cooling	Air cooling
Feed	Hydraulic
Blade drive	Via V-belt
Feed speed	0–61 m/min

## Design

Electro-hydraulic cutting depth adjustment
Cutting depth indicator
Tool cooling using water fork
Left / right cutting function
Corner flush cutting function

## Dimensions & Weight

Length	1 700 mm
Width	870 mm
Height	1 160 mm
Weight	840 kg

## System & Accessories

Floor saw FSE1240	
10984045	Floor saw FSE1240S
<i>Diesel particle filter and transformation set on request</i>	

★★★  
PREMIUM

## Floor saw FSD1274

Cutting depth up to 480 mm



Maximum power transmission by means of built-in longitudinal engine with angle gear box



Saw blade coupling and neutral position mechanism for increased safety

Floor saw with powerful and economical, built-in longitudinal 74 PS Kubota turbo diesel engine. The cutting shaft in the oil bath minimises maintenance work and protects the belts from slurry. An automatic On/

Off function simplifies handling and reduces cooling water consumption. The hydraulic drive system with no belts or chains to adjust and the hydraulic handle adjustment ensure effortless and time-saving work.



# System & Accessories

## Saw blade

Saw blade	Standard	Maximal
Max. cutting depth	230 mm	480 mm
Max. saw blade Ø	600 mm	1 200 mm
Saw blade speed	1 590 1/min	880 1/min
Saw blade holder Ø	25.4 mm	
Carrier Ø	11.5 mm	
Reference circle Ø	57.4 mm	

## Drive

Drive / motor	Diesel
Type	Kubota
Output	55 kW / 74 HP
Fuel	Diesel
Fuel tank	34.2 l
Engine cooling	Water cooling
Feed	Hydraulic
Blade drive	Directly flange-mounted angular gear
Feed speed	0–76 m/min

## Design

Electro-hydraulic cutting depth adjustment
Electro-mechanical cutting depth stop
Hydraulic adjustable handles
Blade clutch
Tool cooling using water fork
Left / right cutting function

Dimensions & Weight	Standard	Maximal
Length	1 615 mm	
Width	927 mm	
Height	1 335 mm	
Weight	937 kg	1 010 kg

## System & Accessories

Floor saw FSD1274	
10985200	Floor saw FSD1274 (Standard configuration)
Accessories	
10990243	Green concrete kit with 500 mm blade guard and transformation set (2 100 1/min) Max. saw blade Ø 500 mm
10990244	900 mm blade guard and transformation set (1 165 1/min) Max. saw blade Ø 900 mm
10990245	1 200 mm blade guard and transformation set (880 1/min) Max. saw blade Ø 1 200 mm

*Diesel particle filter and transformation set on request*

★★★  
PREMIUM

## Floor saw FSD1274 3-Speeds

Cutting depth up to 480 mm



Three speeds for ideal rotational speeds and optimised lifetime



Safe repositioning of the saw thanks to neutral position

Floor saw with powerful and economical, built-in longitudinal 74 PS Kubota turbo diesel engine. The cutting shaft in the oil bath minimises maintenance work and protects the belts from slurry. An automatic On/

Off function simplifies handling and reduces cooling water consumption. The hydraulic drive system with no belts or chains to adjust and the hydraulic handle adjustment ensure effortless and time-saving work.

# System & Accessories

## Saw blade

Saw blade	
Max. cutting depth	480 mm
Max. saw blade Ø	1 200 mm
No Load saw blade speed	1 700/1 250/975 1/min
Saw blade holder Ø	25.4 mm
Carrier Ø	11.5 mm
Reference circle Ø	57.4 mm

## Drive

Drive / motor	Diesel
Type	Kubota
Output	55 kW / 74 PS
Fuel	Diesel
Fuel tank	34.2 l
Engine cooling	Water cooling
Feed	Hydraulic
Blade drive	Directly flange-mounted
Feed speed	0–76 m/min

## Design

Electro-hydraulic cutting depth adjustment
Electro-mechanical cutting depth stop
Hydraulic adjustable handles
Left / right cutting function
Tool cooling using water fork
Engine cover
3 speed gear box with neutral position

## Dimensions & Weight

Length	1 620 mm
Width	927 mm
Height	1 420 mm
Weight	990 kg

## System & Accessories

Floor saw FSD1274	
10989900	Floor Saw FSD1274 3 Speed (1 200 mm guard)

## Accessories

10985254	650 mm (26") blade guard
10989836	750 mm (30") blade guard
10989838	900 mm (36") blade guard
10993459	1 000 mm (42") blade guard

*Diesel particle filter and transformation set on request*







# Drives

---

Machines

180

---

★★  
STANDARD

## Drive PPH25

Power 25 kW



Ergonomically arranged control panel



Safe due to high quality electronic components



Manometer display for main and feed cycle

The 2-stage control ensures optimum cutting speeds for all applications. A simple and uncomplicated drive

with product features reduced to the essentials.



# System & Accessories



## Technical data

### Electric motor

Power	25 kW
-------	-------

### Hydraulic

Pressure stages	2
-----------------	---

2 feed circuits	Gear wheel
-----------------	------------

Main circuit	Dual gear pump
--------------	----------------

### Power

Stage 1	45 l/min at 230 bar
---------	---------------------

Stage 2	50 l/min at 200 bar
---------	---------------------

### Electric

Voltage	400/480 V
---------	-----------

Frequency	50/60 Hz
-----------	----------

Current consumption (400 V / 50 Hz)	42 A
-------------------------------------	------

### Dimensions & Weight

Length	720 mm
--------	--------

Width	475 mm
-------	--------

Height	988 mm
--------	--------

Weight	145 kg
--------	--------

## System & Accessories

### Drive unit PPH25

10984200*	Drive unit PPH25 / 380–420 V / 50 Hz
-----------	--------------------------------------

976206	Hose package 5 pieces 8 m FD
--------	------------------------------

975672	Hose package 2 pieces 8 m FF (feed)
--------	-------------------------------------

### Accessories

973074	El.-plug CEE 63/5 pol.
--------	------------------------

999578	On/off valve for wire sawing
--------	------------------------------

\* Different voltage and frequency types are available upon request.

★★★  
PREMIUM

## Drive PPH25RR

Power 25 kW



Freedom of movement thanks to remote control. All remote control functions are adjustable



Three-way switch, secondary connections, operating hours counter



Plastic cover can be removed without tools

The 4-stage control ensures optimal cutting speeds for all applications and the potentiometer of the remote

control ensures a wire-conserving smooth start / soft start.

# System & Accessories



## Technical data

### Electric motor

Power	25 kW
-------	-------

### Hydraulics

Pressure stages	4
2 feed circuits	Radial piston pump
Main circuit	Triple gear pump

### Output

Stage 1	45 l/min at 230 bar
Stage 2	50 l/min at 200 bar
Stage 3	60 l/min at 170 bar
Stage 4	70 l/min at 140 bar

### Electrical equipment

Voltage	380/480 V
Frequency	50/60 Hz
Current consumption (400 V / 50 Hz)	42 A
2 secondary connections, (230 V / 50 Hz / 10 A (400 V / 50 Hz)	

### Dimensions & Weight

Length	760 mm
Width	550 mm
Height	1 140 mm
Weight	170 kg

## System & Accessories

### Drive unit PPH25RR

10983900*	Drive unit PPH25RR / 380–420 V / 50 Hz / freq. 434 MHz
976206	Hose package 5 pieces 8 m FD
975672	Hose package 2 pieces 8 m FF (feed)

### Accessories

973074	El.-plug CEE 63/5 pol.
--------	------------------------

\* Different voltage and frequency types are available upon request.

★★★  
PREMIUM

## Drive PPH40RR

Power 40 kW



Freedom of movement thanks to remote control. All remote control functions are adjustable



Three-way switch, secondary connections, operating hours counter



Plastic cover can be removed without tools

The 4-stage control ensures optimal cutting speeds for all applications and the potentiometer of the remote

control ensures a wire-conserving smooth start / soft start.

# System & Accessories



## Technical data

### Electric motor

Power	40 kW
-------	-------

### Hydraulics

Pressure stages	4
2 feed circuits	Radial piston pump
Main circuit	Triple gear pump

### Output

Stage 1	65 l/min at 250 bar
Stage 2	75 l/min at 220 bar
Stage 3	80 l/min at 200 bar
Stage 4	90 l/min at 180 bar

### Electrical equipment

Voltage	380/400/460/575 V
Frequency	50/60 Hz
Current consumption (400 V / 50 Hz)	60 A
2 secondary connections, 230 V / 50 Hz / 10 A (400 V / 50 Hz)	

### Dimensions & Weight

Length	820 mm
Width	560 mm
Height	1 260 mm
Weight	238 kg

## System & Accessories

### Drive unit PPH40RR

10983400*	Drive unit PPH40RR / 380–420 V / 50 Hz / freq. 434 MHz
-----------	---

975672	Hose package 2 pieces 8 m FF (feed)
--------	-------------------------------------

976207	Hose package 3 pieces 8 m FD
--------	------------------------------

### Accessories

973074	El.-plug CEE 63/5 pol.
--------	------------------------

\* Different voltage and frequency types are available upon request.





# Free hand

<b>Cutting and grinding</b>	<b>188</b>
Dry cutting	189
Diamond cup wheels	211
Machines	218
<b>Hand- and ring sawing</b>	<b>223</b>
Information	224
Hand- and ring saw blades	226
Machines	228









**Dry cutting**

# New features, new design, trusted quality

The existing dry cutting range from TYROLIT has been revised in terms of its product characteristics and user-friendliness as well as its design.

The result is largely universal tools for all common building materials. We started last year with our PREMIUM line, which was completely revised for the most part. The next step was to renew our STANDARD and BASIC ranges.

<div style="text-align: center;">  <p><b>PREMIUM</b></p> </div> <p><b>Maximum performance and highest lifetime for professional use.</b></p>	<div style="text-align: center;">  <p><b>STANDARD</b></p> </div> <p><b>Exceptional working comfort and efficiency for experienced use.</b></p>	<div style="text-align: center;">  <p><b>BASIC</b></p> </div> <p><b>Quality tools for ideal working results in everyday use.</b></p>
--	--	--



# What is new?

## Increased performance by up to 30%

- + Powerful tools, extremely high cutting speeds and outstanding durability

## Compact assortment

- + Streamlined product palette with solutions for all common construction materials

## Innovative and user-friendly

- + Entirely tailored to current market demands and today's powerful machines

## New look

- + Re-designed segments, clear labels and updated packaging

## Highest product safety

- + Complete assortment in compliance with OSA and EN13236 regulations

# Upgraded segments for outstanding results







**TGD<sup>®</sup> TECHNOLOGY**

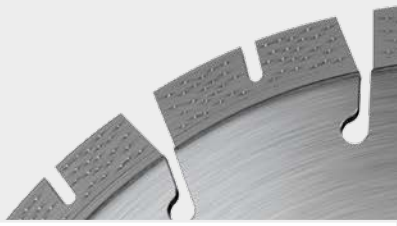

New, even more **intelligent diamond pattern** allows for **more efficiency**









**Increased cooling effect** due to new U-shaped cuts











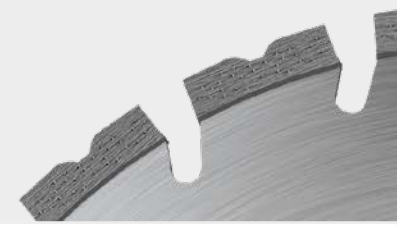

**Performance increase** due to new segment shape









**Reduced segment surface** ensures a higher cutting rate

Free hand

The composition of the segments is different for all quality lines.

# A new assortment for doers

A major part of the TYROLIT Dry Cutting Assortment has been substantially reworked with a clear focus on the user. Thus, the assortment boasts solutions for all kinds of users.

## For all-rounders

### DCU in TGD® Technology



The upgrade of our top-selling universal disc with even better performance.

★★★ PREMIUM TGD® TECHNOLOGY

### DCU



The constant companion for those who want to tackle various tasks with one durable disc.

★★★ PREMIUM ★★ STANDARD ★ BASIC

### DCU-FAST CUT



Gets the job done faster: The high-performing version of our universal classic.

★★★ PREMIUM ★★ STANDARD ★ BASIC

### DCE-SILENT in TGD® Technology



Noise-damped and universal: The SILENT version for an all-round application with electric machines.

★★★ PREMIUM TGD® TECHNOLOGY

### CUT-ALL



The long-lasting all-rounder for unlimited material processing and rescue operations.

★★★ PREMIUM



### For rock-stars

**DCH in TGD® Technology**



Rock-solid: THE TGD® disc for cutting hard stone ensures unmatched results.

★★★ PREMIUM TGD® TECHNOLOGY

**DCH**



Cutting-edge: Guarantees clean and break-out-free edges.

★★★ PREMIUM ★ BASIC

**DCH-FAST CUT**



Getting there faster with less grinding pressure: The fast cutting version of our professional hard stone disc.

★★★ PREMIUM

### For down-to-earth users

**DCA+C**



Hard-line cutting of asphalt and concrete.

★★★ PREMIUM ★★ STANDARD ★ BASIC

### For concrete pros

**DCC**



The first choice for cutting any type of concrete.

★★★ PREMIUM ★★ STANDARD

### For sanitary champions

**DCP**



Outstanding for processing of porcelain stoneware and tiles.

★★★ PREMIUM

Free hand

### Application recommendation Dry Cutting Assortment

		★★★ PREMIUM											★★ STANDARD					★ BASIC				
		DCU TGD®	DCU	DCU-FAST CUT	DCU-SILENT *	DCE-SILENT **	DCC	DCC-FAST CUT	DCH TGD®	DCH	DCH-FAST CUT	DCA+C	CUT-ALL	DCU	DCU-FAST CUT	DCC	DCC-LONG LIFE	DCA+C	DCU	DCU-FAST CUT	DCH	DCA+C
Universal Construction Materials	Concrete	●	●	●	●	●	●	●	●	●	●	○	○	○	○	○	○	○	○	○	○	○
	Armed concrete	●	○	○	○	○	●	○	●	○	○	○	○	○	○	○	○	○	○	○	○	○
	Cellular concrete	●	●	●	●	●	○	●	●	●	●	○	○	●	○	○	○	○	○	○	○	○
	Natural stone	○	○	○	○	○	○	●	●	●	●	○	○	○	○	○	○	○	○	○		
	Hard materials	●	●	●	●	○	●	●	●	●	●		○	○	○	○	○	○	○	○	○	○
	Roofing materials	○	○	●	○	○	○	●	○	○	●		○	○	○	○	○	○	○	○	○	○
	Bricks	●	●	●	●	●	●	●	●	●	●	●	○	●	●	●	●	●	○	○	●	●
	Masonry	●	●	●	●	●	●	●	●	●	●	●	○	●	●	●	●	●	●	●	●	●
Hard Stone	Hard limestone	●	●	○	●	●	●	○	●	●	●	○	○	●	○	○	○	○	○	○	○	○
	Concrete blocks	●	●	●	●	●	●	●	●	●	●	○	○	●	●	●	●	○	○	○	○	○
	Granite	○	○	●	○	○	○	●	●	○	●	○	○	○	○	○	○	○			○	
	Quartz	○	○	●	○	○	○	●	●	○	●		○	○	○	○	○	○			○	
	Paving slab	●	○	○	○	○	●	○	●	○	○	○	○	●	○	○	●	○	○	○	○	○
Asphalt & Concrete	Green concrete	○	●	○	●	●	●	○	○	●	○	○	○	●	○	○	○	○	○	○	○	○
	Floor pavement	●	●	○	●	●	●	○	●	●	○	●	○	●	○	○	○	○	○	○	○	○
	Plaster	●	●	●	●	●	●	●	●	●	●	●	○	●	●	●	●	●	○	○	○	○
	Asphalt	○	○	○	○	○	○	○	○	○	○	●	○	○	○	○	○	○	○	○		○
	Sandstone	●	●	●	●	●	●	●	●	●	●	●	○	●	○	●	●	○	○	○	○	○
Marble	Marble	○							○	○	○											
Industrial Ceramics	Refractory materials	○							○			○		○	○	○						
	Engineering bricks	●	○	○	○			○	●	○	○	○		○	○	○						

● = optimal ○ = good ○ = acceptable " " = not recommended

\*For wet cutting \*\*For wet cutting, only for electric machines

### Application recommendation Dry Cutting Assortment

		★★★ PREMIUM						★ BASIC
		DCM	DCT	DCP	DCCI Combi	DCCI	CUT-ALL	DCT
Marble 	Marble	●						
Soft Materials 	GFK	●					○	
	PVC	●			●		○	
	Carbon fibre	●	●	○	●	○	○	○
	Composites	●			●	○	○	○
	Fibreglass	●	○				○	○
	Bulletproof glass	●					●	○
Tiles & Ceramics 	Ceramic tiles	○	○	●			○	○
	Fine stoneware	○	○	●			○	
	Porcelain	○	●	●			○	○
Metal 	Cast iron					●	●	
	Steel					○	○	
	Grey cast iron					●	●	
	Spheroidal cast iron					●	●	





● = optimal ○ = good ○ = acceptable " " = not recommended

\*For wet cutting \*\*For wet cutting, only for electric machines

Free hand





★★★ PREMIUM **DCU dry cutting saw blades** for universal construction materials | in TGD® Technology 

Machinable materials: Universal construction materials such as heavily reinforced concrete, natural stone, clay brick, cellular concrete etc.

	Shape	Type number	Dimension	Segment height		
		C3W	34468871	230 × 2.4 × 22.23	14	
			C73W	34434257	300 × 2.6 × 20	
	34462046		300 × 2.6 × 22.23	14		
	34462047		300 × 2.6 × 25.4	14		
	34435145		350 × 3.2 × 20	14		
	34462048		350 × 3.2 × 22.23	14		
	34462049		350 × 3.2 × 25.4	14		
	34435148		400 × 3.2 × 20	14		
	34462050		400 × 3.2 × 25.4	14		

★★★ PREMIUM **DCU dry cutting saw blades** for universal construction materials 

Machinable materials: universal building materials such as reinforced concrete, natural stone, clay brick, masonry, hard stone, abrasive materials, etc.

	Shape	Type number	Dimension	Segment height			
		C73W	34430790	115 × 2.4 × 22.23	10		
			34425401	125 × 2.4 × 22.23	10		
			34430832	150 × 2.6 × 22.23	12		
			34430833	180 × 2.6 × 22.23	12		
			34434386	230 × 2.6 × 22.23	12		
			34428610	300 × 2.6 × 20	12		
			34431007	300 × 2.6 × 22.23	12		
			34431008	300 × 2.6 × 25.4	12		
			34430834	350 × 3.2 × 20	12		
			34430835	350 × 3.2 × 22.23	12		
			34430836	350 × 3.2 × 25.4	12		
			34428721	400 × 3.2 × 20	12		
			34431009	400 × 3.2 × 25.4	12		





**DCU-FAST CUT dry cutting saw blades**  
for universal construction materials



Machinable materials: universal building materials such as concrete, clay brick, masonry, hard stone, granite etc.

Fast and clean, no edge chipping. Not suitable for reinforced concrete.

Shape	Type number	Dimension	Segment height
  C6R	474743	115 × 2 × 22.23	10
	474746	125 × 2 × 22.23	10
	474751	150 × 2.4 × 22.23	9
	474752	180 × 2.4 × 22.23	9
	474753	230 × 2.4 × 22.23	9





**DCU-SILENT dry cutting saw blades**  
for universal construction materials



Machinable materials: universal building materials such as concrete, clay brick, masonry, hard stone, concrete blocks etc.

Reduces noise by up to 10 dB.

Shape	Type number	Dimension	Segment height
  C3G	474771	230 × 2.6 × 22.23	9





**DCE-SILENT dry cutting saw blades**  
for universal construction materials | in TGD® Technology



Machinable materials: universal building materials such as concrete, clay brick, masonry, concrete blocks etc.

Only for electric cutting machines.  
Reduces noise by up to 10 dB.





Shape	Type number	Dimension	Segment height
  C73GW	34461143	350 × 3.2 × 20	14
	34461144	400 × 3.2 × 20	14
	34517728	350 × 3.2 × 25.4	14
	34517729	400 × 3.2 × 25.4	14

Free hand

**NEW** ★★ **STANDARD** **DCU dry cutting saw blades**  
for universal construction materials



Machinable materials: Universal building materials, such as reinforced concrete, clay brick, natural stone, etc.



	Shape	Type number	Dimension	Segment height	
		C73	34499934	115 × 2 × 22.23	7
		34499935	125 × 2 × 22.23	7	
		34499936	150 × 2.6 × 22.23	9	
		34499937	180 × 2.6 × 22.23	9	
		34499938	230 × 2.6 × 22.23	9	
		C7W	34499792	300 × 2.6 × 20	10
		34499793	300 × 2.6 × 22.23	10	
		34499794	300 × 2.6 × 25.4	10	
		34499795	350 × 3.2 × 20	10	
		34499796	350 × 3.2 × 25.4	10	
		34499797	400 × 3.2 × 20	10	

**NEW** ★★ **STANDARD** **DCU-FAST CUT dry cutting saw blades**  
for universal construction materials



Machinable materials: Universal building materials such as concrete, clay brick, natural stone, etc. Fast and clean, no edge chipping.

Not suitable for reinforced concrete.



	Shape	Type number	Dimension	Segment height	
		C3R	34499939	115 × 2 × 22.23	7
		34499940	125 × 2 × 22.23	7	
		C3R	34499991	150 × 2.4 × 22.23	9
		34499992	180 × 2.4 × 22.23	9	
		34499993	230 × 2.4 × 22.23	9	
		467433	300 × 3 × 20	10	
		467434	300 × 3 × 22.23	10	
		467435	300 × 3 × 25.4	10	
		467436	350 × 3 × 20	10	
		467439	350 × 3 × 25.4	10	

**NEW** ★ **BASIC** **DCU dry cutting saw blades**  
for universal construction materials





Machinable materials: Universal building materials, such as reinforced concrete, clay brick, natural stone, etc.

Details: A 20–16 mm reduction bush is supplied with a disc diameter of 105 mm.

	Shape	Type number	Dimension	Segment height	
		C73	34502315	105 × 2 × 20/16	7
		34501337	115 × 2 × 22.23	7	
		34501338	125 × 2 × 22.23	7	
		34501445	150 × 2.6 × 22.23	9	
		34501446	180 × 2.6 × 22.23	9	
		34501447	230 × 2.6 × 22.23	9	



Shape	Type number	Dimension	Segment height	
 	C7W	34501448	300×2.6×20	10
		34501449	300×2.6×22.23	10
		34501450	300×2.6×25.4	10
		34501461	350×3.2×20	10
		34501462	350×3.2×25.4	10
		34501463	400×3.2×20	10
		34502116	400×3.2×25.4	10





**NEW**  **DCU-FAST CUT dry cutting saw blades**  
for universal construction materials



Machinable materials: Universal building materials, such as concrete, clay brick, natural stone, etc. Fast and clean, no edge chipping.

Not suitable for reinforced concrete. Details: A 20-16 mm reduction bush is supplied with a disc diameter of 105 mm.



Shape	Type number	Dimension	Segment height	
 	C3R	34502314	105×2×20/16	7
		34501464	115×2×22.23	7
		34501465	125×2×22.23	7
	C3R	34501466	150×2.4×22.23	9
		34501467	180×2.4×22.23	9
		34501468	230×2.4×22.23	9
		467280	300×3×20	10
		467281	300×3×22.23	10
		467282	300×3×25.4	10
		467285	350×3×20	10
	467288	350×3×22.23	10	
	467289	350×3×25.4	10	



 **FSU Floor saw blade**  
for universal building materials



Materials able to be machined: Universal building materials, such as concrete, clay brick, natural stone, etc.



Shape	Type number	Dimension	Segment height	
 	C3W	34546443	450×3.6×25.4	10
		34573300	500×3.6×25.4	10



**DCC dry cutting saw blades**  
for concrete



Machinable materials: concrete, armed concrete, concrete products, hard materials etc.

Shape	Type number	Dimension	Segment height	
 	C73W	34468730	115 × 2.4 × 22.23	10
	34468731	125 × 2.4 × 22.23	10	
	34468732	150 × 2.6 × 22.23	12	
	34468733	180 × 2.6 × 22.23	12	
	34468734	230 × 2.6 × 22.23	12	
	34468735	300 × 2.6 × 20	12	
	34468736	300 × 2.6 × 22.23	12	
	34468737	300 × 2.6 × 25.4	12	
	34468738	350 × 3.2 × 20	12	
	34468739	350 × 3.2 × 22.23	12	
	34468740	350 × 3.2 × 25.4	12	
	34468751	400 × 3.2 × 20	12	
	34468752	400 × 3.2 × 25.4	12	





**DCC-FAST CUT wall chaser blade**  
for concrete



Machinable materials: Concrete, clay brick, cellular concrete.  
Details: Tool for the milling of slots in concrete and masonry.







For use with all common wall chasers.

Shape	Type number	Dimension	Segment height	
 	C3R	598008	125 × 2 × 22.23	7
	598010	140 × 2.4 × 22.23	9	
	598011	150 × 2.4 × 22.23	9	

**NEW** ★★ **STANDARD** **DCC dry cutting saw blades**  
for concrete





Machinable materials: Concrete, reinforced concrete, concrete products, hard materials, etc.

	Shape	Type number	Dimension	Segment height	
		C73			
		34500109	115 × 2 × 22.23	7	
		34500110	125 × 2 × 22.23	7	
		34500111	150 × 2.6 × 22.23	9	
		34500112	180 × 2.6 × 22.23	9	
34500113	230 × 2.6 × 22.23	9			
		C7W			
		34500114	300 × 2.6 × 20	10	
		34500115	300 × 2.6 × 25.4	10	
		34500116	350 × 3.2 × 20	10	
		34500117	350 × 3.2 × 25.4	10	
34502313	400 × 3.2 × 20	10			

★★ **STANDARD** **DCC-LONG LIFE dry cutting saw blades**  
for concrete



Machinable materials: Concrete, reinforced concrete, concrete products, hard materials, etc.

	Shape	Type number	Dimension	Segment height
		C3W		
		484994	300 × 2.6 × 20	10
		484996	300 × 2.6 × 22.23	10
		484999	300 × 2.6 × 25.4	10
		485001	350 × 3 × 20	10
		485003	350 × 3 × 22.23	10
485004	400 × 3.2 × 20	10		

Free hand





**DCA+C dry cutting saw blades**  
for asphalt & concrete



Machinable materials: asphalt, green concrete with soft to hard material aggregates and a small amount of cured concrete.

Details: Protective segments against the undercutting-effect for blades with a dia of 300 or more.

Shape	Type number	Dimension	Segment height
	C73W 34470453	115 × 2.4 × 22.23	10
	34470454	125 × 2.4 × 22.23	10
	34470455	150 × 2.6 × 22.23	12
	34470456	180 × 2.6 × 22.23	12
	34470457	230 × 2.6 × 22.23	12
	C73SW 34472010	300 × 2.6 × 20	10
	34472041	300 × 2.6 × 22.23	10
	34472044	300 × 2.6 × 25.4	10
	34472046	350 × 3.2 × 20	10
	34472061	350 × 3.2 × 22.23	10
	34472008	350 × 3.2 × 25.4	10
	34474151	400 × 3.2 × 25.4	10



**FSA+C Floor saw blade**  
for asphalt & concrete



Machinable materials: asphalt, green concrete with soft to hard material aggregates and a small amount of cured concrete.

Details: Protective segments against the undercutting-effect.

Shape	Type number	Dimension	Segment height
	C7SW 34527692	450 × 3.6 × 25.4	10
	34573481	500 × 3.6 × 25.4	10



**DCA+C dry cutting saw blades**  
for asphalt & concrete



Machinable materials: Asphalt, green concrete with soft to hard material aggregates and a small amount of cured concrete.



Details: Protective segments against the undercutting-effect.

Shape	Type number	Dimension	Segment height
	C7SW 34502234	300 × 2.8 × 20	10
	34502235	300 × 2.8 × 25.4	10
	34502236	350 × 3.2 × 20	10
	34502237	350 × 3.2 × 25.4	10
	34502455	400 × 3.2 × 20	10
	34502238	400 × 3.2 × 25.4	10

**NEW** **BASIC** **DCA+C dry cutting saw blades**  
for asphalt & concrete





Machinable materials: Asphalt, green concrete with soft to hard material aggregates and a small amount of cured concrete. Details: Protective segments against the undercutting-effect.

Shape	Type number	Dimension	Segment height
  C7SW	34500101	300×2.8×20	10
	34500102	300×2.8×25.4	10
	34500103	350×3.2×20	10
	34500104	350×3.2×25.4	10
	34502456	400×3.2×20	10
	34500105	400×3.2×25.4	10

**BASIC** **FSA Floor saw blade**  
for asphalt



Materials able to be machined: Asphalt, sandstone, extremely abrasive materials. Details: Protective segments against the undercutting-effect.

Shape	Type number	Dimension	Segment height
  C1SW	34546444	450×3.6×25.4	10
	34573482	500×3.6×25.4	10

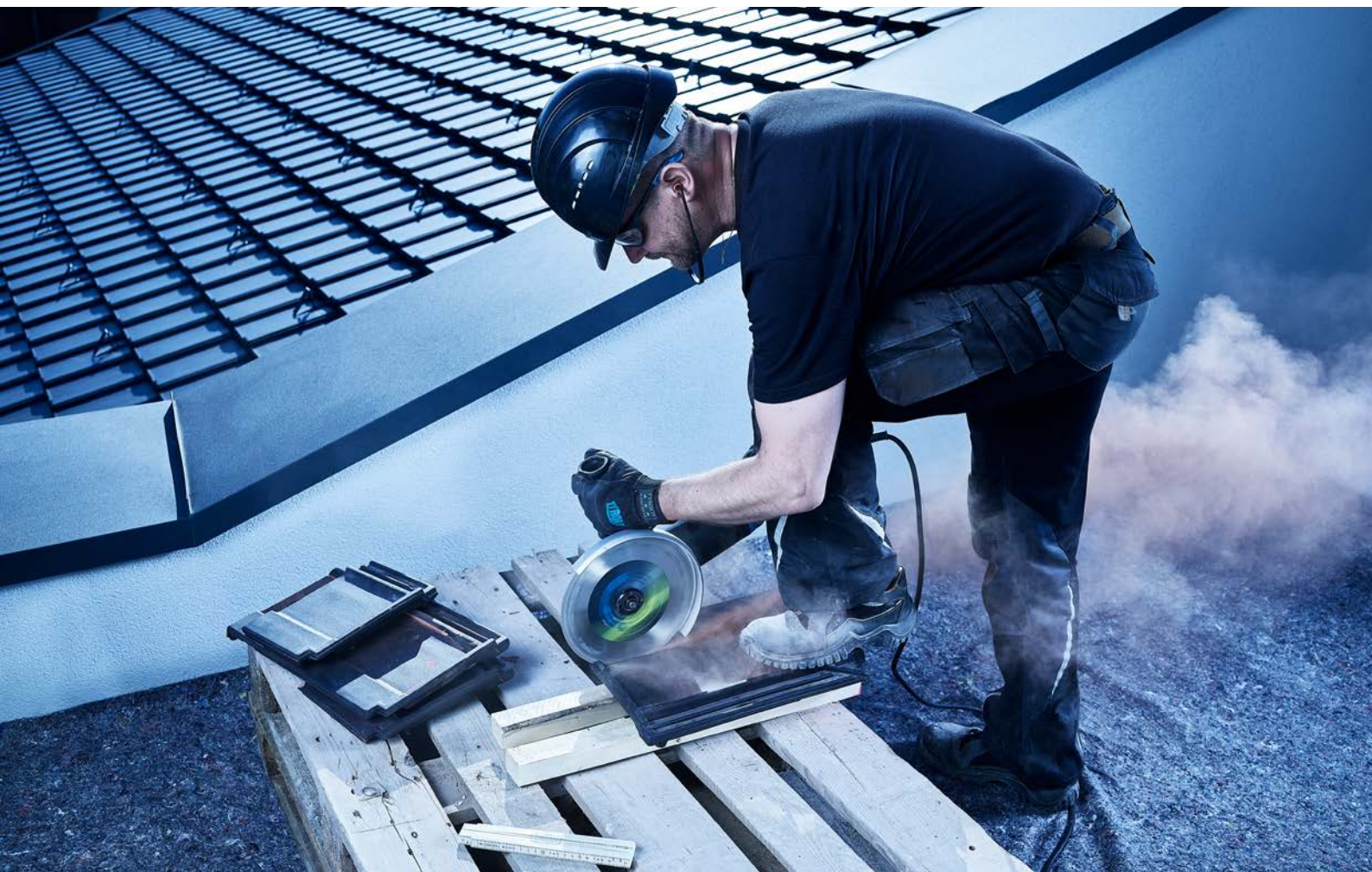







**DCH dry cutting saw blades**  
for hard stone | in TGD® Technology



Machinable Materials: Concrete blocks, granite, gneiss, porphyry, paving slab etc.



	Shape	Type number	Dimension	Segment height		
		C3W	34468872	230 × 2.4 × 22.23	14	
		C73W	34435150	300 × 2.6 × 20	14	
		34462092	300 × 2.6 × 25.4	14		
		34435151	350 × 3.2 × 20	14		
		34462093	350 × 3.2 × 25.4	14		
		34435152	400 × 3.2 × 20	14		
	34462094	400 × 3.2 × 25.4	14			



**DCH dry cutting saw blades**  
for hard stone



Machinable materials: Granite, gneiss, porphyry, paving slab, hard limestone, etc.



	Shape	Type number	Dimension	Segment height	
		C73W	34475858	115 × 2.4 × 22.23	10
		34475856	125 × 2.4 × 22.23	10	



**DCH-FAST CUT dry cutting saw blades**  
for hard stone



Machinable materials: Granite, gneiss, porphyry, paving slab, hard limestone, etc.

	Shape	Type number	Dimension	Segment height	
		C3	475790	115 × 1.2 × 22.23	7
		475793	125 × 1.2 × 22.23	7	
		C3W	475797	180 × 1.9 × 22.23	9
		475800	230 × 1.9 × 22.23	9	



**NEW** ★ **BASIC** **DCH dry cutting saw blades**  
for hard stone



Machinable materials: Granite, porphyry, paving slab, hard limestone, etc.

	Shape	Type number	Dimension	Segment height	
		C73	34501469	115 × 2 × 22.23	7
		34501470	125 × 2 × 22.23	7	
		34501471	180 × 2.6 × 22.23	9	
		34501472	230 × 2.6 × 22.23	9	
		C7W	34501473	300 × 2.6 × 20	
		34501474	350 × 3.2 × 20	10	

**NEW** ★★★ **PREMIUM** **CUT-ALL**  
for any materials



Machinable materials: universal building materials, concrete, stone, cast iron, composite materials, plastic, glass, wood, sheets and metal sections. Ideal for emergency operations by fire brigade and rescue forces.

	Shape	Type number	Dimension	Segment height	
		UC3	34503209	115 × 2.8 × 22.23	3
		34502746	125 × 3 × 22.23	3	
		34503208	230 × 3 × 22.23	3	
		34503261	350 × 4.1 × 20	3	
		34503262	350 × 4.1 × 25.4	3	

★★★ **PREMIUM** **DCAB Tuck point blade**  
for abrasive materials



Machinable materials: Mortar joints. Details: tool for milling and repairing mortar joints.



	Shape	Type number	Dimension	Segment height
		FRSU	563873	115 × 7.2 × 22.23
		535829	125 × 7.2 × 22.23	7

Free hand

★★★ PREMIUM **DCM dry cutting saw blades for marble**





Machinable materials: Marble, fibreglass reinforced plastic, PVC, carbon fibre, composites, fibreglass, bulletproof glass, etc.

Shape	Type number	Dimension	Segment height
  UC3	315968	115 × 2.5 × 22.23	2
	315967	125 × 2.5 × 22.23	2
	547611	150 × 3 × 22.23	2
	315966	180 × 3 × 22.23	2
	315965	230 × 3 × 22.23	2
	490961	350 × 3 × 20	2.5
	490962	350 × 3 × 25.4	2.5

NEW ★★★ PREMIUM **DCP dry cutting saw blades for porcelain stoneware & tiles**





Machinable materials: Porcelain stoneware, fine stoneware, ceramic tiles, kitchen counter tops.

Shape	Type number	Dimension	Segment height
  1A1R	34529134	115 × 1.4 × 22.23	10
	34529153	125 × 1.4 × 22.23	10

★★★ PREMIUM **DCT dry cutting saw blades for tiles & ceramics**



Machinable materials: Ceramic tile, fine stoneware, porcelain. Details: A 20–16 mm reduction bush is supplied with a disc diameter of 105 mm.



Shape	Type number	Dimension	Segment height
  1A1R	639558	105 × 1 × 20	10
	639559	115 × 1.2 × 22.23	10
	639560	125 × 1.2 × 22.23	10
	639634	180 × 1.4 × 22.23	10
	676791	200 × 1.6 × 22.23	10
	639635	230 × 1.6 × 22.23	10

**★**  
**BASIC**

### DCT dry cutting saw blades for tiles & ceramics



Machinable materials: Ceramic tiles.

Shape	Type number	Dimension	Segment height
  1A1R	475975	100 × 1.6 × 22.23	7
	475978	115 × 1.6 × 22.23	7
	475980	125 × 1.6 × 22.23	7
	475983	180 × 2 × 22.23	9
	475986	230 × 2 × 22.23	9

### Accessories dry cutting saw blades Sharpening plate for tiles





Type number	Dimension
SP6	55 × 25 × 320
34574956	320 × 55 × 320

**★★★**  
**PREMIUM**

### Roofer's cutting wheel for all common roofing materials





Shape	Type number	Dimension	Segment height
  C6R	103283	230 × 2.4 × 22.23	9

**NEW**

**★★**  
**STANDARD**

### Roofer's cutting wheel for all common roofing materials





Shape	Type number	Dimension	Segment height
  C3R	34485652	230 × 2.4 × 22.23	9

★★★ PREMIUM **DCCI Diamond cut-off wheel**  
for grey and spheroidal cast iron





DCCI diamond cut-off wheels from TYROLIT are the optimum tool for machining grey and spheroidal cast iron. These products combine a long lifetime with maximum economic efficiency.

Shape	Type number	Dimension	Segment height
  UC3	34551885	115 × 2.8 × 22.23	3
	34551886	125 × 3 × 22.23	3
	34551884	230 × 3 × 22.23	3
	34367418	350 × 4.1 × 20	3
	34551887	350 × 4.1 × 25.4	3



★★★ PREMIUM **DCCI Combi cutting and chamfering disc**  
for plastic pipes



Shape	Type number	Dimension	Segment height
  UC3	34228075	125 × 3 × 22.23	3

**Sharpening plate**  
Accessories dry cutting saw blades

Type number	Dimension
SP1 497322	55 × 25 × 320
484627	160 × 30 × 320
484672	320 × 55 × 320

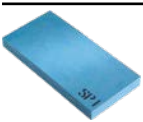













## Diamond cup wheels





## Diamond cup wheels for angle grinders

TYROLIT diamond cup wheels enable quick and accurate grinding of uneven concrete, stone and floor pavement surfaces. In addition to their universal range of applications, high stock removal rates and a long lifetime are main characteristics of TYROLIT diamond cup wheels.

### Service

- + Quick delivery
- + Available in all relevant diameters
- + Conventional dimensions on stock

### Remarks / recommendations

- + Observe safety and user instructions
- + On request safety instructions may also be sent separately

# Application recommendation



Performance Level	Specification	Hard stone	Concrete	Abrasive materials	Universal	Pages
<b>★★★</b> <b>PREMIUM</b>	DGU Turbo				●	214
	DGU				●	215
<b>★★</b> <b>STANDARD</b>	DGU Single row				●	215
	DGU Double row				●	215
	DGU Turbo				●	216
	DGU-T   Continuous				●	216
	DGAB			●		216
	DGC			●		217
	DGH	●				217
	DGU-FAST CUT				●	217



## DGU-Turbo Diamond cup wheels

for universal building materials | W-Segment

+ **Fine grinding surface pattern and clean shaping of corners and edges**  
due to turbo style arranged segments.

+ **Quick dust removal.**



+ **Impressive performance and lifetime.**

Machinable materials: Concrete, natural stone and general building materials. Details: Turbo style arranged



segments for a fine grinding surface pattern and shaping of corners and edges. Quick dust removal.

A 22.23–16 mm reduction bush is supplied with a wheel diameter of 100 mm.



### DGU-Turbo Diamond cup wheels for universal building materials | W-Segment





	Shape	Type number	Dimension	Segment height
	 STS-T	598061	100×20×22.23	5
		34179930	125×23×22.23	5
		34179971	180×32×22.23	5

**★★★ PREMIUM** **DGU Diamond cup wheels**  
for universal building materials





Machinable materials: Concrete, natural stone and general building materials. Details: With PU foam coating for quiet grinding and shaping of corners and edges.

	Shape	Type number	Dimension	Segment height
		STHD		
		356569	100 × 18 × 22.23	5
		350694	110 × 18 × 22.23	5
		367833	110 × 18 × M14	5
		348387	125 × 18 × 22.23	5
		828013	180 × 19 × 22.23	5

**★★ STANDARD** **DGU Diamond cup wheels**  
for universal building materials | Single row





Machinable materials: Concrete, natural stone and general building materials. Details: Single row segments for high stock removal. A 22.23–16 mm reduction bush is supplied.

	Shape	Type number	Dimension	Segment height	
		STS-S	494333	100 × 18 × 22.23	5

**★★ STANDARD** **DGU Diamond cup wheels**  
for universal building materials | Double row



Machinable materials: Concrete, natural stone and general building materials. Details: Double row segments for medium stock removal and long lifetime. A 22.23–16 mm reduction bush is supplied with wheel diameters of 100 and 110 mm.

	Shape	Type number	Dimension	Segment height
		STS-D		
		494339	100 × 18 × 22.23	5
		494349	110 × 18 × 22.23	5
		494361	125 × 18 × 22.23	5
		494394	180 × 32 × 22.23	5

Free hand





### DGU-Turbo Diamond cup wheels for universal building materials



Machinable materials: Concrete, natural stone and general building materials. Details: Turbo style arranged segments for a fine grinding surface pattern and shaping of corners and edges.

Quick dust removal. A 22.23–16 mm reduction bush is supplied with a wheel diameter of 100 mm.

	Shape	Type number	Dimension	Segment height
		STS-T	494342	100 × 18 × 22.23
			494365	125 × 20 × 22.23
			494391	180 × 32 × 22.23





### DGU-T Diamond cup wheels for universal building materials | Continuous



Machinable materials: Concrete, natural stone and general building materials. Details: Turbo style arranged segments for exceptional surface finish

and high grinding power.

	Shape	Type number	Dimension	Segment height
		STS-TC	34247005	100 × 18.5 × 22.23
			34247126	115 × 18.5 × 22.23
			34247127	125 × 18.5 × 22.23
			34247128	180 × 18.5 × 22.23





### DGAB Diamond cup wheels for abrasive materials | T-Segment



Machinable materials: Abrasive concrete, cellular concrete, floor pavement, plaster, pumice stone, etc.

Details: Grinding disc with T-segment for abrasive materials. Excellent grinding power.



	Shape	Type number	Dimension	Segment height
		STS-TS	34247129	100 × 21 × 22.23
			34247130	115 × 21 × 22.23
			34247151	125 × 21 × 22.23
			34247152	180 × 30.2 × 22.23



### DGC Diamond cup wheels for concrete | T-Segment



Machinable materials: Concrete and general building materials. Details: Grinding disc with T-segment for universal use. Excellent grinding power.

	Shape	Type number	Dimension	Segment height
		STS-TS	34247153	100 × 21 × 22.23
			34247154	115 × 21 × 22.23
			34247155	125 × 21 × 22.23
			34247156	180 × 30.2 × 22.23





**DGH Diamond cup wheels**  
for hardstone | T-Segment



Machinable materials: Natural stone, granite and hard building materials. Details: Grinding disc with T-segment for hard materials. Excellent grinding power.

	Shape	Type number	Dimension	Segment height
		STS-TS	34247157	100 × 21 × 22.23
			34247158	115 × 21 × 22.23
			34247159	125 × 21 × 22.23
			34247160	180 × 30.2 × 22.23



**DGU-FAST CUT Diamond cup wheels**  
for universal building materials | L-Segment



Machinable materials: Concrete and general building materials. Details: Grinding disc with L-segment, with particularly large holes for better extraction, for universal use. Fast Cut Version – very high stock removal rate.

	Shape	Type number	Dimension	Segment height
		STS-LS	34247161	100 × 20.5 × 22.23
			34247162	115 × 20.5 × 22.23
			34247164	125 × 20.5 × 22.23
			34247165	180 × 30 × 22.23



**DGU-PCD Diamond cup wheel**  
for coatings and glue residues | with protection segments



Removal of glue residues, plastic and resin based coatings (e.g. epoxy resin, acrylic, ...), thermoplastic coatings, mastic, on cementitious surfaces.

Details: Polycrystalline diamond (PCD) is an extremely hard material. Cup wheels with PCD segments can be used to remove tenacious materials and coatings. Aggressive performance and long lifetime. Protection segments for even and smooth grinding results.

	Shape	Type number	Dimension	Segment height
		STS-S	34558007	125 × 22 × 22.23



**DGU-PCD Diamond cup wheel**  
for coatings and glue residues



Removal of glue residues, plastic and resin based coatings (e.g. epoxy resin, acrylic, ...), thermoplastic coatings, mastic, on cementitious surfaces.

Details: Polycrystalline diamond (PCD) is an extremely hard material. Cup wheels with PCD segments can be used to remove tenacious materials and coatings. Aggressive performance and long lifetime.

	Shape	Type number	Dimension	Segment height
		STS-S	34558008	125 × 22 × 22.23

Free hand

## Angle grinder AGE125

Blade diameter of 125 mm



Universal angle grinder  
Ø 125 mm for processing  
construction materials and  
metal



Extremely durable and  
efficient motor for high  
performance



Electronics with soft  
start, restart and  
overload protection

The compact AGE125 angle grinder is useful for a wide range of applications and is a must-have for any craftsman, with its durable motor, high level of efficiency, and electronics with features such as a soft start, restart and overload protection. The anti-kickback feature

turns off the motor on the disc being blocked, ensuring safe operation. Effective cooling and extensive dust seal increase the lifetime of the angle grinder. In addition, the blade guard is tool-free adjustable and the slide switch is lockable.

# System & Accessories

## Technical data

Max. Ø of saw blade	125 mm
Blade arbour	M14

## Drive

Drive / motor	Electric
Voltage / frequency	220-240 V/50-60 Hz
Motor power	900 W
No load speed	11,500/min

## Dimensions & weight

Length	300 mm
Width	75 mm
Height	105 mm
Weight (without blade)	2 kg
Cable length	4 m

## System & Accessories

### Angle grinder AGE125

11002625	Angle grinder AGE125/230 V
----------	----------------------------

### Tool recommendation

34425401	PREMIUM DCU Dry cutting saw blade
----------	-----------------------------------

## Angle grinder AGE230

Blade diameter of 230 mm



Universal angle grinder  
Ø 230 mm for processing  
construction materials and  
metal



Robust, streamlined motor  
and transmission housing  
with vibration damping for  
easy handling



Soft vibration handle for  
reduced vibrations, can be  
mounted in three positions

The AGE230 is a handy, streamlined Ø 230 mm angle grinder with vibration damping and longer handle, incl. a soft inlay for secure grip, a soft start feature and a blade guard that can be adjusted without tools. The robust steel transmission and

a protected metal spindle bearing ensure reliability in use and a longer lifetime. As you would expect, this model has restart protection in case of power failure, a lock-on/off switch and a spindle lock.

# System & Accessories

## Technical data

Max. Ø of saw blade	230 mm
Blade arbour	M14

## Drive

Drive / motor	Electric
Voltage / frequency	220-240 V/50-60 Hz
Motor power	2,100 W
No load speed	6,500/min

## Dimensions & weight

Length	490 mm
Width	104 mm
Height	90 mm
Weight (without blade)	5.4 kg
Cable length	4 m

## System & Accessories

### Angle grinder AGE230

11002626	Angle grinder AGE230/230 V
----------	----------------------------

### Tool recommendation

34468871	PREMIUM DCU TGD® Dry cutting saw blade
----------	--









## Hand- and ring sawing





## Hand- and ring saw blades

The leadership of TYROLIT is based on years of experience in the fields of production and application of hand saw blades. This allows us to provide innovative solutions for large scale projects and at the same time, our tools achieve efficient results in everyday use at construction sites.

Hand saw blades are especially suitable for openings and breaking through walls or ceilings with minor depths. TYROLIT ring saw blades



convince with quick and simple handling and clean cutting edges. The outstanding cutting performance remains constant over the whole

blade lifetime. The range of TYROLIT products covers all common applications and machines (electrical, hydraulic, petrol driven).

## Application recommendation

Operation only for wet cutting



Performance Level	Specification	Concrete	Pages
 <b>PREMIUM</b>	HSL TGD®	●	226
	RSL	●	226
	RSL-C	●	227
	RSL-FC	●	227
	RSM	●	227
 <b>STANDARD</b>	HSL-FC	●	226





## Colour indication

Low Power /  
for hard, non-abrasive materials







Medium Power /  
for soft, abrasive materials



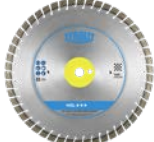

★★★ **PREMIUM**  **HSL Hand saw blade**  
for concrete | in TGD®-Technology   



Machinable materials: Usage on reinforced or normal concrete with wall thicknesses of up to 150 mm. Details: Application in system with fuel operated, electric or hydraulic cut-off machines.

	Shape	Type number	Dimension	Segment height	
		C77W	54902	405 × 2.8 × 25.4	10
			732290	416 × 2.8 × 25.4	10



★★ **STANDARD**  **HSL-FAST CUT Hand saw blade**  
for concrete  



Machinable materials: Usage on reinforced or normal concrete with wall thicknesses of up to 150 mm. Details: Application in system with fuel operated, electric or hydraulic cut-off machines.

	Shape	Type number	Dimension	Segment height	
		C7W	34291707	350 × 4.2 × 25.4	10



★★★ **PREMIUM**  **RSL Ring saw blade**  
for concrete | Ø 406 mm / 506 mm  

Machinable materials: Usage on reinforced or normal concrete with wall thicknesses of up to 400 mm (Ø 506 mm) / 300 mm (Ø 406 mm). Details: The ring saw blades have been optimised to work perfectly with the TYROLIT Hydrostress machines. With every replacement blade the wear plate is included and should also be replaced with each ring saw blade.

	Shape	Type number	Dimension	Segment height	
		C1W	738471	406 × 3.9 × 326.8	10
			738473	506 × 3.9 × 421.7	10

★★★ **PREMIUM**  **RSL Ring saw blade**  
for concrete | Ø 366 mm  

Machinable materials: Usage on reinforced or normal concrete with wall thicknesses of up to 260 mm. Details: Application in system with fuel operated, electric or hydraulic ring saw machines. With every replacement blade the wear plate is included and should also be replaced with each ring saw blade.



	Shape	Type number	Dimension	Segment height	
		C1W	739886	366 × 4.2 × 288	10

★★★ PREMIUM ● **RSL-C Ring saw blade**  
for concrete | Ø 406 mm

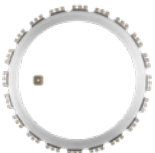

Machinable materials: Usage on reinforced or normal concrete with wall thicknesses of up to 300 mm (Ø 406 mm). Details: The ring saw blades have been optimised to work perfectly with the TYROLIT Hydrostress

machines. With every replacement blade the wear plate is included and should also be replaced with each ring saw blade.



	Shape	Type number	Dimension	Segment height
		C1W	34506869	406 × 4.2 × 320
			34058668	406 × 3.9 × 326.78

★★★ PREMIUM ● **RSL-FAST CUT Ring saw blade**  
for concrete | Ø 306 mm / Ø 406 mm

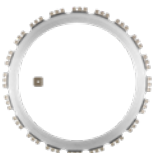

Machinable materials: For fast cutting on reinforced or normal concrete with wall thicknesses of up to 300 mm (Ø 406 mm). Details: The ring saw blades have been optimised to work perfectly with the TYROLIT

Hydrostress machines. With every replacement blade the wear plate is included and should also be replaced with each ring saw blade.



	Shape	Type number	Dimension	Segment height
		C1W	34249061	306 × 3.9 × 225.2
			34258692	406 × 3.9 × 326.78
			34438701	406 × 3.9 × 320

★★★ PREMIUM ● **RSM Ring saw blade**  
for concrete | Ø 366 mm



Machinable materials: Usage on reinforced or normal concrete with wall thicknesses of up to 260 mm. Details: Application in system with fuel operated, electric or hydraulic ring saw machines.

With every replacement blade the wear plate is included and should also be replaced with each ring saw blade.

	Shape	Type number	Dimension	Segment height
		C1W	739887	366 × 4.2 × 288

● = low

● = medium

★★★  
PREMIUM

## Hand saw HBE400

Cutting depth up to 150 mm



405 mm saw blade with cutting depth up to 150 mm and flush cutting function with optional accessories



3.2 kW electric motor with fully integrated electronics



Integrated dust extraction connection for dust-free, clean working

The HBE400 is a 3.2 kW hand-held saw for cutting depths up to 150 mm. In combination with our accessories kit, this hand-held saw is excellently suited to flush cutting.

This model can be used for both wet and dry applications and its integrated dust extraction connection enables clean working. The compact design, low weight and detachable

guide rollers guarantee ease of handling and machine guidance for the user. The 230 V electric drive enables flexible working indoors and outdoors.



# System & Accessories

## Technical data

Saw blade	
Max. cutting depth	150 mm
Max. saw blade Ø	405 mm
Saw blade uptake	25.4 mm

## Drive

Drive / motor	Electric
Voltage / frequency	230 V / 50–60 Hz
Power	3.2 kW

## Dimensions & Weight

Length	735 mm
Width	259 mm
Height	365 mm
Weight (without blade)	9.1 kg

## System & Accessories

Hand saw HBE400	
10991700	Hand saw HBE400 / 230 V

## Accessories

10998741	Flush cut kit (Hole pattern 7M243)
----------	------------------------------------

## Tool recommendation

34462050	PREMIUM DCU TGD® Dry cutting saw blade
----------	--

★★★  
PREMIUM

## Ring saw HRE410

Depth of cut up to 300 mm



Ideal cutting performance due to a 6.5 kW P2® motor in conjunction with TYROLIT ring saw blades



Intelligent ergonomics – handle can be rotated 90° for horizontal cuts



Modular use with WSE1621 wall saw system or electric control unit PPE6

The HRE410 is an electric hand saw for wall and floor cuts to a depth of 300 mm. The ring saw is an ideal supplement to the WSE1621 wall saw system, enabling work without overcuts and therefore provides a

better alternative to corner drilling or diamond chain saws. The combination of a powerful 6.5 kW P2® motor and TYROLIT ring saw blades ensures exceptional cutting performance – for fast, precise

work. The intelligent ergonomics are another feature of this machine; the rear and front handle can be adjusted to enable an ideal position for cutting with less fatigue.

# System & Accessories



## Technical data

Saw blade	
Max. depth of cut	300 mm
Max. ring saw blade Ø	410 mm

## Drive

High-frequency motor	
Power	6.5 kW
Speed	1938 rpm
Cooling	Water

## Design

Modular use with WSE1621
P2 <sup>®</sup> high-frequency technology
Adjustable, ergonomic handles
Front handle for left- and right-handed users
Rear handle can be rotated 90°
Water intake can be controlled directly on handle
IP 55 protection class
Overload and excess temperature display

## Dimensions & weight

Length	505 mm
Width	320 mm
Height	520 mm
Weight	14.5 kg

## System & Accessories

Ring saw HRE410/Electric control WSE1621	
10999300	Ring saw HRE410
11002700	Electric control WSE1621 400V
11002643	Transport case HRE410

Ring saw HRE410/Electric control PPE6	
10999300	Ring saw HRE410
11000500	Electric control PPE6 400V 10A IP65 12.5kg
11002643	Transport case HRE410

34438701	Ring saw blade RSL-FC (C1W 406x3.9x320)
34506869	Ring saw blade RSL (C1W 406x4.2x320)
11002010	Drive wheel



TYROLIT

HYDROSTRESS



# Table sawing

<b>Information</b>	<b>234</b>
<b>Table saw blades</b>	<b>236</b>
<b>Machines</b>	<b>240</b>











## Diamond saw blades for table saws

TYROLIT table saw blades impress with an excellent cutting performance and a long lifetime. They are optimised for the relevant material or application.

TYROLIT table saw blades are developed to work perfectly with TYROLIT Hydrostress machines and therefore

meet all cutting work challenges and deliver the best results.

## Application recommendation

Performance Level	Specification	 Universal	 Hard stone	 Engineering bricks	 Abrasive materials	 Soft stone	 Tiles	Pages
★★★ PREMIUM	TSU	•						236
	TSU-SILENT	•						237
	TSH		•					237
	TSH-SILENT		•					237
	F40				•			237
	TSS10			•				238
	ES-T						•	238
	DCT							•

### Service

- + Quick delivery
- + Available in all relevant diameters
- + All relevant dimensions on stock
- + Designed to perfectly harmonise with TYROLIT Hydrostress machines
- + Reduction bushes for various machine types

### Remarks / Recommendations

- + Please observe the safety and user instructions
- + On request safety instructions may also be sent separately
- + Maximum working speed 63 m/s
- + Tools only to be used for wet-cutting (exceptions are explicitly stated)



# TSU Table saw blade

for universal building materials

+ **Universal use**  
for various building materials, such as clay brick, concrete, sand-lime brick, etc.

+ **Maximum performance and lifetime.**



+ **Broad product range.**

Materials able to be machined:  
Cellular concrete, sand-lime brick, pumice stone, clay brick, etc. Details: 35–30 mm and 30–25.4 mm reduction

bushes are included with disc diameters up to 550 mm. A 60–55 mm reduction bush is supplied with disc diameters of 625 mm and upwards.



## TSU Table saw blade for universal building materials



	Shape	Type number	Dimension	Segment height
		C2W		
		34180849	250 × 2.2 × 35	10
		34180294	300 × 2.4 × 35	10
		34180293	350 × 2.8 × 35	10
		34180291	400 × 3.2 × 35	10
		34180270	450 × 3.2 × 35	10
		34218744	500 × 3.6 × 35	10
		34180268	550 × 3.6 × 35	10
	C1W	34180263	625 × 3.6 × 60/55	10
		34171018	650 × 3.9 × 60/55	10
		34171019	700 × 3.9 × 60/55	10
		34171020	900 × 4.8 × 60/55	10
		34171031	1000 × 4.8 × 60/55	10





### TSU-SILENT Table saw blade for universal building materials



Materials able to be machined: Cellular concrete, sand-lime brick, pumice stone, clay brick, etc. Reduces noise by up to 10 dB.

Details: 35–30 mm and 30–25.4 mm reduction bushes are included with disc diameters up to 550 mm. A 60–55 mm reduction bush is supplied with disc diameters of 625 mm and upwards.

	Shape	Type number	Dimension	Segment height
		C2GW	34180292	350 × 2.8 × 35
			34485805	400 × 3.2 × 35
		C1GW	34181275	625 × 3.6 × 60
			34180295	700 × 3.9 × 60/55
			34305288	900 × 4.8 × 60/55
				10





### TSH Table saw blade for hardstone



Materials able to be machined: Granite, gneiss, hard sand-lime brick, hard clay brick.

Details: 35–30 mm and 30–25.4 mm reduction bushes are supplied.

	Shape	Type number	Dimension	Segment height
		C2	34277672	250 × 2.2 × 35
			34221327	300 × 2.8 × 35
			34221325	350 × 2.8 × 35
			34495775	400 × 3.2 × 35
				14





### TSH-SILENT Table saw blade for hardstone



Materials able to be machined: Granite, gneiss, hard sand-lime brick, hard clay brick. Reduces noise by up to 10 dB.

Details: 35–30 mm and 30–25.4 mm reduction bushes are supplied.



	Shape	Type number	Dimension	Segment height
		C2G	34221324	300 × 2.8 × 35
			34097755	350 × 2.8 × 35
				14



### F40 Table saw blade for abrasive materials



Materials able to be machined: Type F40 is designed primarily for refractory cutting.

	Shape	Type number	Dimension	Segment height
		C2W	817603	350 × 2.8 × 25.4
			817607	400 × 3.2 × 25.4
			547136	500 × 3.6 × 25.4
				7





### TSS10 Table saw blade for engineering bricks



Materials able to be machined: Type TSS10 has been specially designed for the machining of engineering bricks (e.g. Stradalit).

Details: 35–30 mm and 30–25.4 mm reduction bushes are supplied.



	Shape	Type number	Dimension	Segment height
	 C1	894258	350×2.8×35	9



### ES-T Table saw blade for marble



Materials able to be machined: Soft stone, such as marble and sand-lime brick. Details: 35–30 mm and 30–25.4 mm reduction bushes are supplied.

	Shape	Type number	Dimension	Segment height
	 C2	5684	300×2.4×35	7
		5685	350×2.8×35	7





### DCT Table saw blade for tiles and ceramic materials



Materials able to be machined: Ceramic tiles, fine stoneware, porcelain, terrazzo slabs.

Details: ultra-thin saw blades with excellent properties. 35–30 mm and 30–25.4 mm reduction bushes are supplied.

	Shape	Type number	Dimension	Segment height
	 1A1R	639566	180×1.4×35	10
		701934	200×1.6×35	10
		639568	230×1.6×35	10
		639569	250×1.6×35	10
		639570	300×2×35	10
		639571	350×2×35	10

### Accessories dry cutting saw blades Sharpening plate for tiles



	Type number	Dimension
	SP6	55×25×320
	34574956	320×55×320







★★★  
PREMIUM

## Tile saw TRE250

Cutting depth up to 60 mm



Cutting length up to 1 m for cutting large tiles



Clean cuts thanks to precise saw head guide and robust design



Safe and easy transport thanks to folding feet and transport wheels

The TRE250 tile saw enables the cutting of various tile sizes and types to a cutting length of 1 m. A range of adjustment and application options ensure maximum flexibility. The

robust design and precise saw head guide guarantee a clean cut. Transport wheels and folding table feet facilitate transport and position at the location of use.

# System & Accessories

## Technical data

Saw blade	
Max. cutting depth	60 mm
Max. saw blade Ø	250 mm
Cutting length	940 mm (1 050 mm)*
Saw blade speed	2 800 rpm
Saw blade holder Ø	25.4 mm

\* Plunge cut

## Drive

Drive / motor	Electric
Output	1.3 kW
Standard voltage / frequency	230 V / 50 Hz
Optional voltage / frequency	110 V / 60 Hz
Engine cooling	Air cooling
Saw blade drive	Direct

## Design

Infinitely adjustable cutting depths
Angle cutting function (angle stop)
Mitre cutting function
Cap cutting function
Electric water pump
Folding legs

## Dimensions & Weight

Length	1 375 mm
Width	740 mm
Height	1 275 mm
Weight	79 kg

## System & Accessories

Tile saw TRE250	
10989500	Tile saw TRE250 / 230 V
10989100	Tile saw TRE250 / 110 V

## Accessories

10995459	Side splash guard
10995489	Parallel guide

## Tool recommendation

639569	PREMIUM DCT Table saw blade
--------	-----------------------------

★★  
STANDARD

## Masonry saw TBE400

Cutting depth up to 125 mm



Swivelling saw head enables 45° mitre cuts



Folding feet, transport wheels and carrying handles ensure total manoeuvrability at the location of use

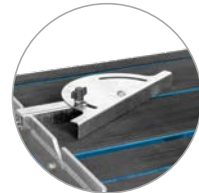

Angle stop provided for cuts of 30° to 90°

The TBE400 table saw offers an uncompromising price-performance ratio as well as high flexibility through numerous settings and application options. A sturdy saw table with anti-slip support guarantees clean cuts. The swivelling saw head allows mitre

cuts to be made with ease. Transport wheels and folding table feet facilitate transport and position at the location of use.

# System & Accessories

## Technical data

Saw blade	
Max. cutting depth	125 mm
Max. saw blade Ø	400 mm
Cutting length	600 mm
Saw blade speed	2 800 rpm
Saw blade arbour Ø	25.4 mm

## Drive

Drive / motor	Electric
Power	2.2 kW
Voltage / standard frequency	230 V / 50 Hz
Motor cooling	Air cooling
Saw blade drive	Direct

## Design

Continuously variable cutting depth
Angle cutting function (angle stop)
Mitre cutting function (swivelling saw head)
Cap cutting function
Water tank made of powder-coated steel
Easy to replace electric water pump
Folding feet and transport handles

## Dimensions & weight

Length	1 210 mm
Width	655 mm
Height	1 285 mm
Weight	86 kg

## System & Accessories

Masonry saw TBE400	
10998400	Masonry saw TBE400 / 230 V
Tool recommendation	
34180291	PREMIUM TSU Table saw blade



★★★  
PREMIUM

## Masonry saw TME700

Cutting depth up to 270 mm



Removable water tank for easier cleaning



Sturdy, balanced transport hook for easy crane transport

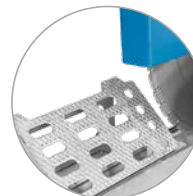

Precise mitre cutting thanks to mitre stop

The TME700 convinces through maximum stability and robustness. The precise stainless-steel saw table guide guarantees a clean cut. Construction-site suitable leading pulleys, forklift guides and a crane hook ensure trouble-free transport.

The anti-contamination positioning of the water pump reduces servicing requirements to a minimum and ensures permanent tool cooling. The intelligent blade guard construction enables quick and easy blade installation.

# System & Accessories

## Technical data

Saw blade	
Max. cutting depth	270 mm
Max. saw blade Ø	700 mm
Cutting length	600 mm
Saw blade speed	1 380 rpm
Saw blade holder Ø	60 mm
Carrier Ø	11.5 mm
Reference circle Ø	120 mm

## Drive

Drive / motor	Electric
Output	5.5 kW
Standard voltage / frequency	400 V / 50 Hz
Engine cooling	Air cooling
Saw blade drive	Direct

## Design

Infinitely adjustable cutting depths
Angle cutting function (angle stop)
Mitre cutting function (swiveling saw head)
Transport hook and fork lift guides
Pull-out water tank
Electric water pump

## Dimensions & Weight

Length	1 470 mm
Width	910 mm
Height	1 350 mm
Weight	220 kg

## System & Accessories

Masonry saw TME700	
10989600	Masonry saw TME700 / 400 V

## Accessories

10978735	Mitre stop (Jolly table)
----------	--------------------------

## Tool recommendation

34171019	PREMIUM TSU Table saw blade
----------	-----------------------------

★★★  
PREMIUM

## Masonry saw TME1000

Cutting depth up to 380 mm



Large cutting depths to 380 mm possible (with saw blade Ø 1 000 mm)

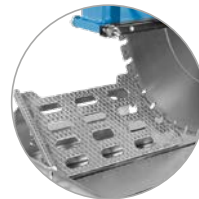

Precise mitre cutting due to mitre stop



Fork lift guides for easy and secure transport

The TME1000 convinces through maximum stability and robustness. The precise stainless-steel saw table guide guarantees a clean cut. Construction-site suitable leading pulleys, forklift guides and a crane hook ensure trouble-free transport.

The intelligent blade guard construction enables quick and easy blade installation. Servicing requirements are reduced to a minimum due to low-maintenance saw blade drive via a transmission.

# System & Accessories

## Technical data

Saw blade	
Max. cutting depth	380 mm
Max. saw blade Ø	1 000 mm
Cutting length	660 mm
Saw blade speed	910 rpm
Saw blade holder Ø	60 mm
Carrier Ø	11.5 mm
Reference circle Ø	120 mm

## Drive

Drive / motor	Electric
Output	7.5 kW
Standard voltage / frequency	400 V / 50 Hz
Engine cooling	Air cooling
Saw blade drive	Via gears

## Design

Infinitely adjustable cutting depths
Angle cutting function (angle stop)
Mitre cutting function (optional mitre stop)
Transport hook and fork lift guides
Pull-out water tank
Electric water pump

## Dimensions & Weight

Length	1 800 mm
Width	1 030 mm
Height	1 500 mm
Weight	324 kg

## System & Accessories

Masonry saw TME1000	
10989800	Masonry saw TME1000 / 400 V

## Accessories

10978735	Mitre stop (Jolly table)
----------	--------------------------

## Tool recommendation

34171031	PREMIUM TSU Table saw blade
----------	-----------------------------

★★★  
PREMIUM

## Cellular concrete band saw TBS510

Cutting height up to 510 mm



Fast, simple saw band replacement thanks to quick-release fastener



Automatic saw band shutdown ensures no unnecessary load on the saw band

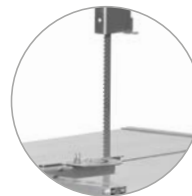

Constant and optimum saw band tension for excellent cutting accuracy and long life time

The TBS510 cellular concrete band saw is designed for the machining of cellular concrete and all kinds of bricks. The ideally sized saw band rollers guarantee durability and the automatic saw band tensioning system enables consistent band tension for exceptional cutting

accuracy and reduced risk of fracture on the saw band. A particular feature is the low need for maintenance ensured due to the direct drive of the saw band wheels. Cuttings are removed freely thanks to the large opening in the lower saw roller box.



# System & Accessories

## Technical data

Cutting height	510 mm
Cutting length	700 mm
Saw band length	3 750 mm
Saw rollers Ø	500 mm
Bar / saw band outlet	490 mm
Max. load bearing capacity of saw bench	50 kg

## Drive

Motor	Electric
Power	1.5 kW / 230 V
Current consumption	12.5 A

## Dimensions & weight

Max. saw bench dimensions	920 / 710 mm
Length	1 080 mm
Width	750 mm
Height	1 840 mm
Weight	173 kg

## System & Accessories

<b>Cellular concrete band saw TBS510</b>	
11000101	Cellular concrete band saw / 230 V, incl. saw band
<b>Tool recommendation</b>	
34453058	HM saw band, length 3,750 x 27 mm, 3 teeth/inch





# Other

Filter presses	252
Pressing and crushing	254
Notes	263



★★★  
PREMIUM

## Filter press SPP400

Cake volume 2.4 litres



Clear, user-friendly control panel

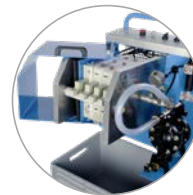

Filter unit



Suction pump

The SPP400 filter press was specially developed for small construction sites and, due to its compact design, is the most mobile and easiest to use filter press on the market. Thanks to its low weight, patented air cushion

technology and trolley chassis, one-man operation is no problem.

With this filter press, TYROLIT enables concrete and stone slurry to be disposed of in an expert and

environmentally friendly way. The recycled water can be discharged into the sewers or reused without problem, and the residues (cakes) in the filter can be disposed of at low cost as building rubble.

# System & Accessories

## Technical data

<b>Filter press SPP400</b>	
Brief description	Mobile solution for temporary construction sites
Operation	Compressed air
Required pressure	250 l / 8 bar
Recycling capacity	400–600 l/hr.
Cake volume	2.4 l
<b>Dimensions and weight</b>	
Length	600 mm
Width	630 mm
Height	950 mm
Weight	79 kg
<b>Recommended compressor</b>	
Capacity	340 l/min
Supply pressure	8 bar
Revolutions	1450 rpm

## Other versions

<b>Filter press SPP600</b>	
Brief description	For continuous mobile or stationary use on construction sites
Operation	Compressed air
Required pressure	250 l / 6 bar
Recycling capacity	400–600 l/hr.
Cake volume	6.4 l

### Dimensions and weight

Length	1 200 mm
Width	800 mm
Height	1 620 mm
Weight	320 kg

### Recommended compressor

Capacity	340 l/min
Supply pressure	10 bar
Revolutions	1 450 rpm

## Other versions

<b>Filter press SPP1200</b>	
Brief description	High filter capacity for industrial use on large construction sites, in concrete plants and natural stone companies
Operation	Compressed air
Required pressure	500 l / 7 bar
Recycling capacity/hr.	2 000 l/hr. – 160 kg solids
Recycling capacity/cycle	400 l/hr. – 32 kg solids
Cake volume	30 l

### Dimensions and weight

Length	1 200 mm
Width	800 mm
Height	1 600 mm
Weight	520 kg

### Recommended compressor

Capacity	500 l/min
Supply pressure	8 bar

## System & Accessories

<b>Filter presses</b>	
10998274	SPP400
10998275	SPP600
10998276	SPP1200



★★★  
PREMIUM

## Press tool CP-110/BTH350

Pressing force of 110 and 260 tons

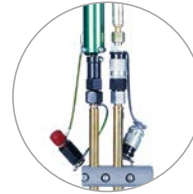

Safety due to special hose connection system



Pressure plates ensure even pressure distribution and pass expansion

TYROLIT pressing tools enable controlled demolition without water, noise, dust or vibrations.

# System & Accessories

## Technical data

	CP-110	BTH350
Pressing force	108 tons	260 tons
Number of pistons	3	2
Stroke	24 mm	50 mm
Required core bore hole Ø (with pressure plate)	130 mm	200 mm
Required core bore hole Ø (without pressure plate)	110 mm	Not recommended
Weight	15 kg	36 kg
Connecting lines	2 off (short/straight)	2 off (long/curved)
High-pressure connection	Screw version	

## System & Accessories

CP-110	
975756	Burster head CP-110 with screw connection

BTH350	
10986983	Burster head BTH350P

### Hydraulic hoses

975604	HP-hose 5 m screwed
975608	Low pressure hose 5 m

### Concrete press system accessories

973886	Male coupling for LP-hose
979401	Cap Ø 20 mm LP-hose
970285	Double fitting for HP-hose
980397	Cup ¼" HP-hose
970301	HP-pipe short straight CP/SP
970303	HP-pipe long straight CP/SP
971383	HP-pipe long bended SP
970271	Pressure plate
978272	Pressure plate CP-110 250 mm

# Drive AU

Working pressure up to 2 000 bar



User-friendly thanks to clear inspection and control panel

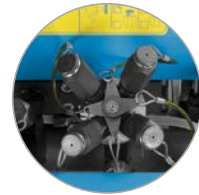

Accessories: Distributor head for 8 pressing tools



Two separately adjustable outputs for controlled pressing work

Suitable for pressing tools CP110 and BTH350. The high-pressure drive generates a pressing force of up to 2 100 tonnes.

# System & Accessories

## Technical data

Hydraulics	
Press force	0.5 l/min at 2 000 bar
Low pressure	2.4 l/min at 150 bar
Booster pressure	14.4 l/min at 80 bar
Oil tank capacity	13 litres

## Motor

Electric motor	Air-cooled
Voltage	200/230/380/400/460 V
Current (400 V / 50 Hz)	10 A
Frequency	50/60 Hz
Output	2.2 kW

## Connections

High pressure	2 pcs. (optionally 8 pcs.)
Low pressure	4 pcs. (optionally 8 pcs.)

## Dimensions & Weight

Length	750 mm
Width	560 mm
Height	755 mm
Weight	127 kg

## System & Accessories

Drive unit AU	
975754 *	High pressure drive unit AU 400/50 EU
975761	Tool box

## Accessories

973071	El.-plug CEE 16/5 pol.
974045	4-way HP adaptor unit
960827	2 way inlet connection
970300	Adaptor M24-G¼" for SP
974053	Return nipple complete CP/SP
974054	Screw nipple complete CP/SP
974050	Screwing set CP/SP

\* Different voltage and frequency types are available upon request.

# Crusher BZ

For wall thicknesses of 120 to 300 mm



Distance washer  
(25 and 50 mm)  
for various wall thicknesses



Various pressure head  
accessories



Easy and safe operation

The crusher for controlled demolition without water, noise, dust or vibrations. The weight-optimised

high-strength aluminium body can be comfortably operated by 2 persons.



## System & Accessories

### Technical data

Crusher BZ	
Crushing force	30 tons
Wall thicknesses	120–300 mm

### Dimensions & Weight

Length	530 mm
Width	290 mm
Height	910 mm
Weight	47 kg

### System & Accessories

Crusher BZ	
975197	Crusher BZ
975728	Tool box BZ

### Accessories

977522	Steel point BZ
974203	Special head BZ for stair removal
974204	Pressure head BZ for thickness <150 mm
970632	Distance washer 50 mm
970630	Distance washer 25 mm

## Drive BW-2

Working pressure up to 750 bar



Easy transport due to detachable motor

Suitable for crusher BZ. The small, handy and lightweight drive with removable main motor.

### Technical data

#### Hydraulics

Hydraulic power	7.4 l/min at 750 bar
Oil cooling	Oil/water heat exchanger
Oil tank capacity	6 litres

#### Motor

Motor	Water-cooled electric motor
Voltage	200/230/380/400/460 V
Current (400 V)	16 A
Frequency	50/60 Hz
Output	10 kW

#### Dimensions & Weight

Length	800 mm
Width	510 mm

Height	1,050 mm
--------	----------

Weight with motor	64 kg
-------------------	-------

Weight without motor	34 kg
----------------------	-------

### System & Accessories

#### Drive unit BW-2

975698*	High-pressure drive BW-2 400/50 EU
---------	------------------------------------

#### Accessories

973071	El.-plug CEE 16/5 pol.
--------	------------------------

\* Different voltage and frequency types are available upon request.

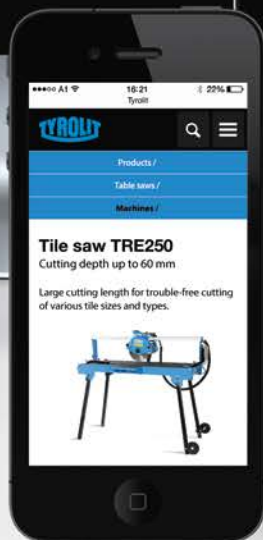
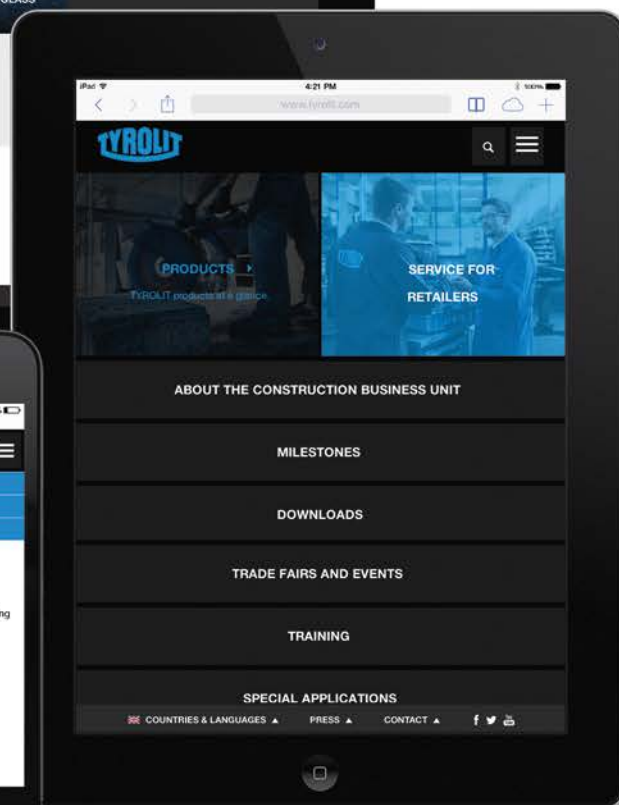
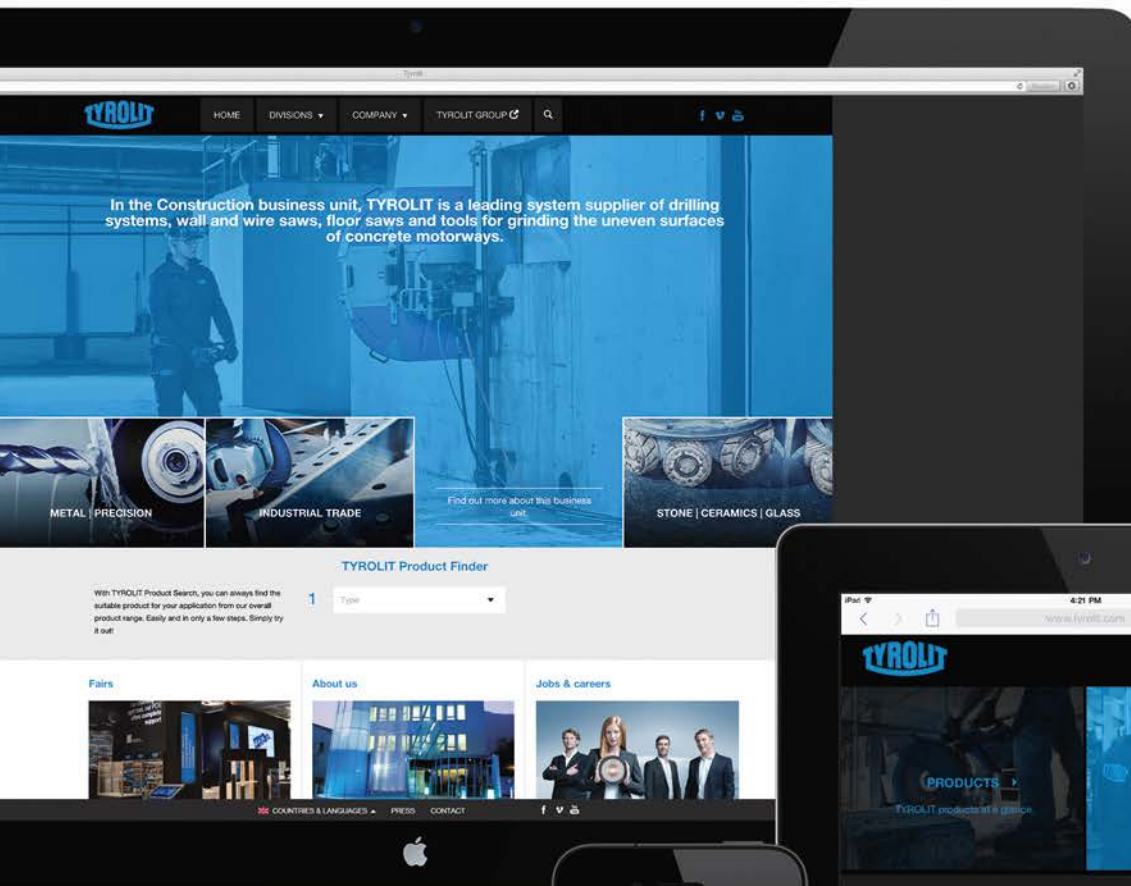

www.tyrolit.com



TYROLIT





**Notes**

Other



# Safety

## Safety and the brand TYROLIT

Our aim was and is to make our products even safer for our users:

Through our work as the founder member of the “Organisation for the Safety of Abrasives” (oSa®), through close cooperation with the safety authorities and through practical communication with our users all over the world.

### For safe working with grinding tools, it is necessary that

- machine manufacturer
- abrasive manufacturer and
- operator

contribute their part in equal measure. TYROLIT guarantees that the tools meet the requirements of the oSa® and the European standards. The CE marking of our machines guarantees the complete compliance with the applicable EU safety requirements.

TYROLIT recommends not to use grinding tools, which do not have the symbols oSa®, EN13236 (diamond tools), EN12413 (cutting and grinding wheels) or EN13743 (flap discs).

## Assembly / repair

Diamond tools must be visually inspected for cracks or other possible damage before mounting. Don't use damaged diamond tools!

The dimension of the diamond tool must correspond to the information on the machine and shouldn't exceed those.

Make sure that the maximum operating speed (RPM) of the tool is not exceeded.

Please note when mounting, that the arrow on the diamond tool corresponds with the direction of rotation of the machine.

Make sure the bore of the diamond tool fits the machine spindle properly – the bore must not be manipulated.

Make sure that the machine spindle is clean and intact. An out of round condition will cause damage to the blade and the saw.

Flanges should be clean, flat, of equal size and of the proper type for the diamond tool. Don't use damaged flanges.

The diamond tool must be properly mounted, rotate freely and the flanges must be tightened properly. Never force a wheel onto the machine.

Only use machines with suitable blade guards.

Disconnect the machine from its power supply before mounting or removing a diamond tool.

Have your machine repaired solely by qualified personnel using original spare parts.



## Application

Avoid unintentional starting of the machine. Make sure that the machine is switched off before connecting to power supply.

Secure the workpiece to prevent accidental slipping.

Support plates or large workpieces in order to reduce the risk of wheel pinching and kickback.

Large workpieces tend to sag under their own weight.

Always wear personal safety equipment and eye protection. Wearing personal safety equipment, such as gloves, non-slip safety shoes, helmet and ear protection, always depending on nature and purpose of the tool, may reduce the risk of injury.

Ensure adequate ventilation and protective measures that correspond to the material to be machined when working with cutting and rough grinding wheels.

Maintain a firm grip on the machine and keep balance at all times. Bring your body into a position where you can intercept kickback forces.

Do not position your head in line with the rotating wheel. Do not position your body in the area in which the machine will move in case of a kickback.

If the cutting wheel gets jamed or when interrupting a cut for any reason, turn off the machine and hold the machine motionless until the wheel comes to a complete stop.

Never attempt to remove the wheel from the cut while the wheel is in motion otherwise kickback may occur. Do not restart the cutting operation in the workpiece. Let the wheel reach full speed before you re-enter the cut.

After turning off the machine, allow the wheel to come to rest naturally. Never use an "artificial" brake such as soil, wood pallets or shoes and never lay the machine down before the wheel has come to rest. The rotating wheel may grab the surface.

## Safety information



Use gloves



Use dust mask



Only permitted for wet grinding



Do not use damaged wheels



Use eye protection



Personal safety



For dry applications



Not permitted for side grinding



Use ear protection



Pay attention to the safety recommendations



Not permitted for wet grinding



No freehand work

# Recommended RPM

Revolutions per minute [RPM] depending on the external tool diameter [D] and the operating speed [VS]							
D in mm	Recommended operating speed VS in m/s						
	Drilling		Sawing			Dry-cutting	
	2	3	40	50	60	80	100
14	2 730	4 090					
16	2 390	3 580					
20	1 910	2 860					
25	1 530	2 290					
32	1 190	1 790					
42	910	1 360					
52	730	1 100					
62	620	920					
72	530	800					
82	470	700					
100	380	570	7 640	9 550	11 460	15 280	19 100
115	330	500	6 640	8 300	9 960	13 290	16 610
125	310	460	6 110	7 640	9 170	12 220	15 280
150	250	380	5 090	6 370	7 640	10 190	12 730
180	210	320	4 240	5 310	6 370	8 490	10 610
200	190	290	3 820	4 770	5 730	7 640	9 550
230	170	250	3 320	4 150	4 980	6 640	8 300
250	150	230	3 060	3 820	4 580	6 110	7 640
300	130	190	2 550	3 180	3 820	5 090	6 370
350	110	160	2 180	2 730	3 270	4 370	5 460
400	100	140	1 910	2 390	2 860	3 820	4 770
450	80	130	1 700	2 120	2 550	3 400	4 240
500	80	110	1 530	1 910	2 290		
600	60	100	1 270	1 590	1 910		
700	50	80	1 090	1 360	1 640		
800	50	70	950	1 190	1 430		
900	40	60	850	1 060	1 270		
1 000	40	60	760	950	1 150		
1 200	30	50	640	800	950		

# Trouble-shooting

## Wet core drill

### 1. Excessive wear of diamond segments

- Insufficient coolant supply. Adjust the water supply and/or check the water lines.
- The operating speed of the core drill is too low. Increase the RPM (see RPM recommendations).
- The engine power is too high. Match the motor power to the drilling diameter.
- The machine is vibrating. Fix the drill rig and/or check the general state of the machine (e.g. bearings and rollers).
- The selected core drill may not be suitable for the material being drilled, or the material is too abrasive. Use a harder specification (e.g. CDL - CDM).

### 2. Excessive wear of the steel tube

- The machine is vibrating. Fix the drill rig and/or check the general state of the machine (e.g. bearings and rollers).
- The core drill is warped / is not running true.
- The core drill is not fixed properly. Check if the core drill is aligned with the motor spindle.
- There are remains in the hole, which have not been removed by the coolant. Increase the coolant supply temporarily.
- You are drilling in loose material (e.g. gravel).

### 3. Broken segments

- In case of brazed segments, a short interruption of the cooling can lead to overheating and thus to a destruction of the soldered joint.
- The core drill has struck multiple times against reinforcements or fragments. Remove all loose steel and segment parts before introducing a new core drill.
- The core drill is cutting into loose reinforcement. Reduce the RPM when drilling reinforcements in order to avoid damage to the core drill.

### 4. Drill bit does not drill Segments are overloaded

Flat segment surface, possible deformation of the segments, high number of pull-outs (>50 %), drill chatters

- The operating speed is too low. Increase the RPM.
- The grinding pressure is too high. Reduce the pressure.
- The material may be too soft and abrasive for the used specification. Use a harder specification (e.g. CDL - CDM).

### 5. Drill bit does not drill Segments are underchallenged

Smooth segment surface, polished diamonds (shining, no sharp edges)

- The diamond segments are smooth (polished).

Re-sharpen the drill bit by drilling into soft, abrasive material or use a TYROLIT sharpening plate.

The operating speed is too high. Reduce the RPM.

The grinding pressure is too low. Increase the pressure.

The engine power is too low. Match the motor power to the drilling diameter.

Excessive coolant supply, only clear water is coming out of the drill hole (no slurry). Reduce the coolant supply and check the consistency (should be milky/cloudy).

The material may be too hard for the used specification. Use a softer specification (e.g. CDL - CDM).

### 6. The core drill is jammed

Debris is blocked between the core and the tube wall (steel, pieces of material). Remove the drill rig and, using a wrench, turn the core drill alternately in both directions until it can be removed. Take the debris out of the drill hole before introducing a new core drill.

The drill rig was not fixed correctly and has moved during drilling. Drill rig and core drill are no longer aligned. Align and re-fix the drill rig.

# Trouble-shooting Diamond saw blade

## 1. Excessive wear

The saw blade is not suitable for the material being cut. Use a harder specification.

Insufficient water supply. Adjust the water supply and/or check the water lines.

The blade is pounding, which accelerates the wearing. The reasons could be poor bearings, a worn spindle shaft or the use of a too hard specification for the material being cut. Check the state of the machine or use a softer specification.

The operating speed (RPM) is too low. Use the correct RPM for the diameter of the blade (see RPM recommendations).

## 2. Undercutting

Undercutting is a condition in which the steel center wears faster than the diamond segment, especially in the areas where the segment and core are joined. This is caused by highly abrasive material grinding against the blade during the sawing operation. Finally this can lead to segment loss.

Be sure to have sufficient water supply. Only with sufficient water the abrasive grinding slurry will be transported out of the contact zone and will thus reduce the undercutting effect.

Do not cut into the sub base of the pavement (lose gravel or sand). The loose material scrubs strongly on the body and tips it below the segments.

**Caution!** For safety reasons, do not use the saw blade any longer!

## 3. The blade does not cut

The saw blade is too hard for the material being cut. Check if the specification is appropriate. A glazed blade can be sharpened by cutting into soft, abrasive material.

The output power of the machine is insufficient to permit the blade to cut properly. Make sure that the specification is appropriate for the machine power and the material being cut. Repeatedly check the tension of the V-belt in order to guarantee an optimal transmission of power.

The speed is too high. To reduce the speed. Should the speed can not be changed can perform the cut in several deliveries.

The blade is not mounted correctly. Look for the correct one-direction of the saw (direction of rotation arrow).

## 4. Overheating

Overheating may lead to several problems like loss of core tension, cracks in the steel core and segment loss (in case of brazed segments). Overheating can be identified by a discoloration (blue and/or black oxidation) of the blade or the segments.

Make sure that wet-cutting saws have a sufficient water supply. Check the water lines and make sure flow is adequate on both sides of blade.

An excessive cutting pressure leads to overheating of dry-cutting tools. Use several passes of 2 to 5 cm deep for cutting solid materials.

On a regular basis, release the pressure on the diamond blade and allow it to rotate freely for cooling in the air. Do not use excessive pressure – the weight of the machine is sufficient.

## 5. Loss of blade segment

The machine was not held firmly or the material was not fixed, which caused the blade to twist or jam in the cut. Secure the material firmly while cutting and maintain a firm grip on the machine.

The blade is too hard for the material being cut which causes the blade to chatter. Use a softer specification.

The blade has been undercut. Make sure that there is sufficient water supply and do not cut into the base layer of the pavement (gravel).

In case of brazed segments, a short interruption of the cooling can lead to overheating and thus to a destruction of the soldered joint.

The saw has not been mounted correctly and starts to chatter.

**Caution!** For safety reasons, do not use the saw blade any longer!



## 6. Cracks in the segment

The saw blade is too hard for the material being cut; the saw blade starts to chatter during cutting. Use a softer specification.

Insufficient cooling supply (overheating). Adjust the water supply and/or check the water lines.

## 7. Cracks in the steel core

The saw blade is too hard for the material being cut. Use a softer specification.

Excessive cutting pressure. Extreme strain on the blade can create material fatigue, which can then lead to a fracture in the steel core.

The saw blade is chattering. Check the state of the machine (e.g. spindle and bearings) and the mounting of the saw blade.

The cut is not straight which results in friction and heat. Properly align the machine and do not exert excessive side pressure on the handles as a method of steering. Check the alignment of the drive shaft.

**Caution!** For safety reasons, do not use the saw blade any longer!

## 8. Uneven segment wear

Make sure that wet-cutting saws have a sufficient water supply. Check the water lines and make sure flow is adequate on both sides of blade.

The saw blade is irregularly worn due to defective bearings, a damaged blade bore or machine spindle. Exchange or repair the bearings and/or spindle. Ensure the engine runs smoothly and does not cause the blade to chatter on a regular cycle basis.

The cut is not straight which results in friction and heat. Properly align the machine and do not exert excessive side pressure on the handles as a method of steering. Check the alignment of the drive shaft.

## 9. Loss of tension

Blade has been overheated. Make sure that wet-cutting saws have sufficient water cooling.

The saw blade is too hard for this application. The reason for the loss of tension is a high lateral friction.

Check if the correct RPM has been chosen and if the proper flanges are being used.

Ensure that the saw blade has been fixed correctly on the spindle. Make sure that drive pins are used for all machines.

The cut is not straight which results in tension and heat. Properly align the machine and do not exert excessive side pressure on the handles as a method of steering. Check the alignment of the drive shaft.

In case of loss of tension send the saw blade back to the manufacturer for repair.

## 10. Damaged bore

The flanges or the spindle are worn out. Check the flanges and spindle for wearing and replace the worn parts.

The saw blade has not been mounted properly. Ensure that the blade is mounted on the proper diameter of spindle. Fix the wheel flanges properly (with a wrench, not by hand). Do not remove the drive pins, because they guarantee an optimal transmission of power.

Send the saw blade back to the manufacturer for repair.

# Working together successfully

We regard our customers as partners. The success of our customers lies in the quality of our products, our knowledge in application technology and the provision of customer-specific on-site solutions. Close collaboration with our customers leads to remarkable strategic developments and ensures long-term success for both parties.

## Promotion as a key factor

For choosing the right tool, the TYROLIT POS system offers complete support. Clear colour guidance systems, pictograms easy to understand and application advices: a flexible and easy to use presentation medium, optionally as Wall Display, Floor Display or Counter Display.

By request we also undertake the planing of your product assortment based on your customers' requirements and advise you on the optimum promotional positioning.



POS

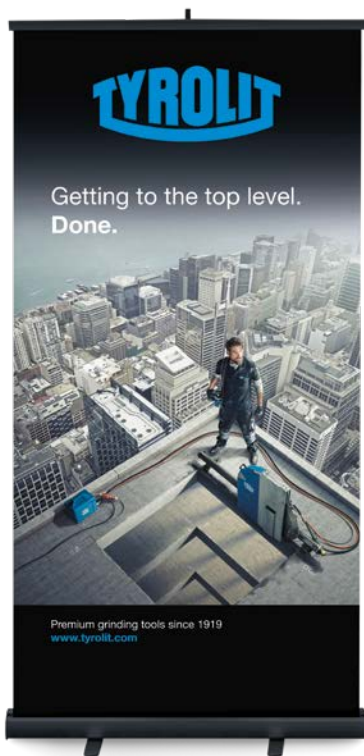

Roll-Up



Poster

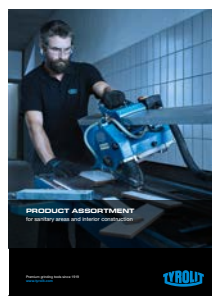

Leaflets



Beach-Flag

# TYROLIT addresses

Find your local representative on our website.  
Please find all locations and contact information  
via the »contact« tab.

[www.tyrolit.com](http://www.tyrolit.com)

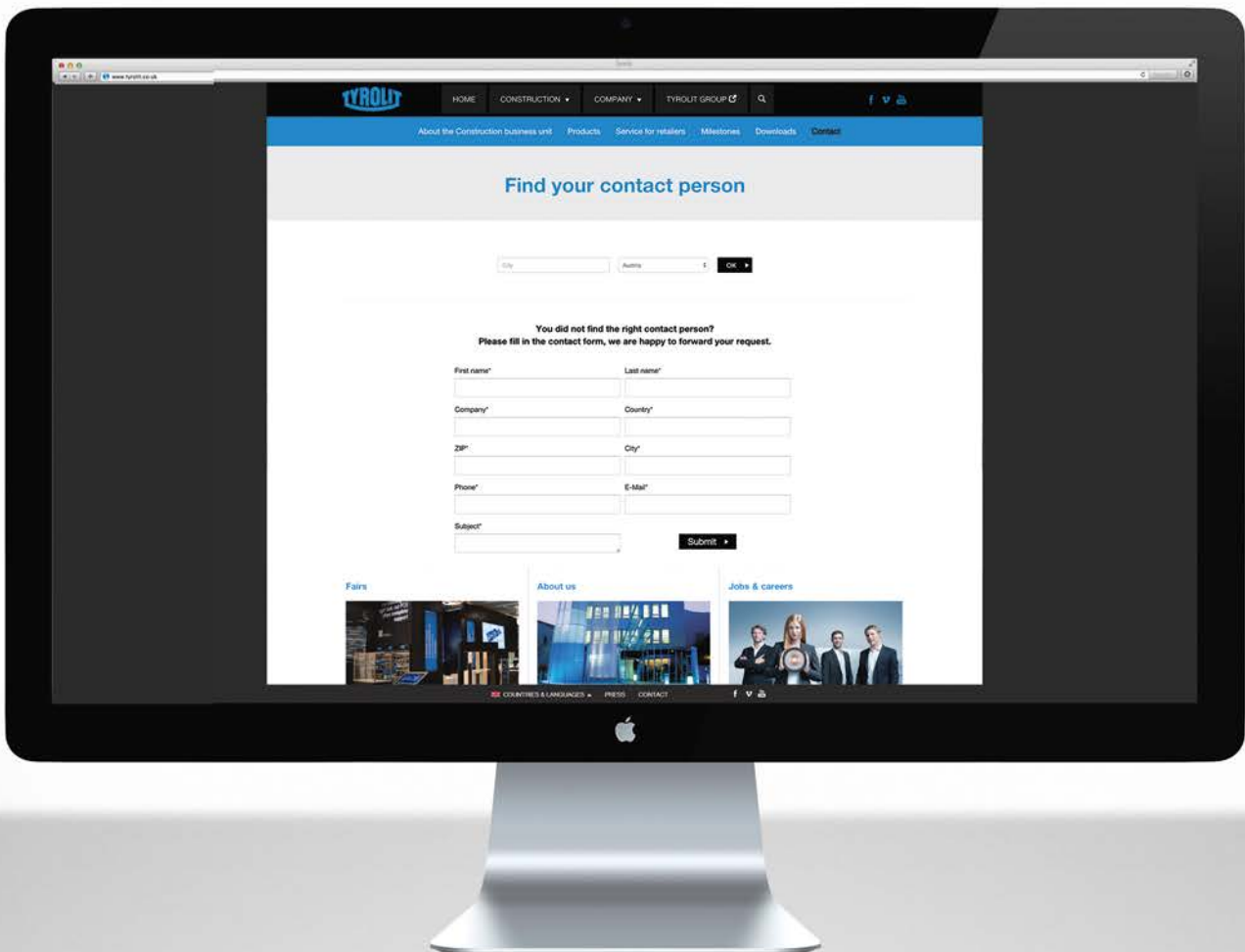

# TYROLIT Project Services

## Special project services at the highest level

TYROLIT is known for reliable diamond technology and premium products. However, we offer much more than merely products for classic areas of application. In addition to renovation solutions, the demolition of bridges and other large-sized structures made from steel and steel-reinforced concrete, the TYROLIT Project Services Team offers competent support even in delicate surroundings, such as nuclear power plants or offshore platforms.



### Adaptable product solutions let customers reach their goals efficiently and economically

For special applications in complex projects, the TYROLIT Project Services Team delivers sophisticated solutions that can be adequately adjusted to the customer's requirements. In addition to the classic concrete drilling and cutting equipment, for example, we offer our customers drilling systems for large-scale drilling diameters and depths, curved tracks or pile cutters for separating pipes and pillars. The adaptation of the products is usually fast and straightforward – true to TYROLIT's philosophy to support customers to get their job done as quickly and efficiently as possible.



### The professional partner in controlled decommissioning

TYROLIT is an especially strong partner in the controlled decommissioning of nuclear power plants and offshore facilities – the supreme discipline of special construction projects. In such high-stakes operations, not only an extremely professional manner of proceeding, but also a great deal of experience is required, no matter where these projects take place. In the past, TYROLIT has already supported customers all over the globe, for instance with the restoration of water dams in Australia and South America, with underwater-cutting in the Atlantic Ocean, or with the decommissioning of nuclear power plants like the one in Belene (Bulgaria).

## The only ATEX-certified wire saw system worldwide comes from TYROLIT

The unique ATEX-certified wire saw system by TYROLIT is mainly used for cutting pipes or other steel structures in working environments where explosion-hazardous gases can escape. TYROLIT is the first supplier worldwide to fulfil the stringent European Union explosion protection directive.

- + Certified for explosion hazardous areas (EX Zone 1, II 2G, IIA c T3)
- + Modular, combinable system, also suitable for the use with already certified drives
- + Robust DWH-S ATEX diamond wire with a very high cutting performance, an outstanding lifetime, noticeable smooth running and a high number of beads
- + Hydraulic SB wire saw with large wire storage (up to 10 m), high power transfer thanks to multiple roller transfer, and hydraulic wire tensioner
- + PPH40RR drive with certified protective cabin
- + For all metals except for titanium
- + Wire speed 10 – max. 18 m/s





## Our services for special projects comprise

- + Feasibility studies
- + Planning concepts
- + Principle sketches
- + Customised products for machines & tools
- + Project management
- + Trainings

Find out more at [www.tyrolit.com](http://www.tyrolit.com)





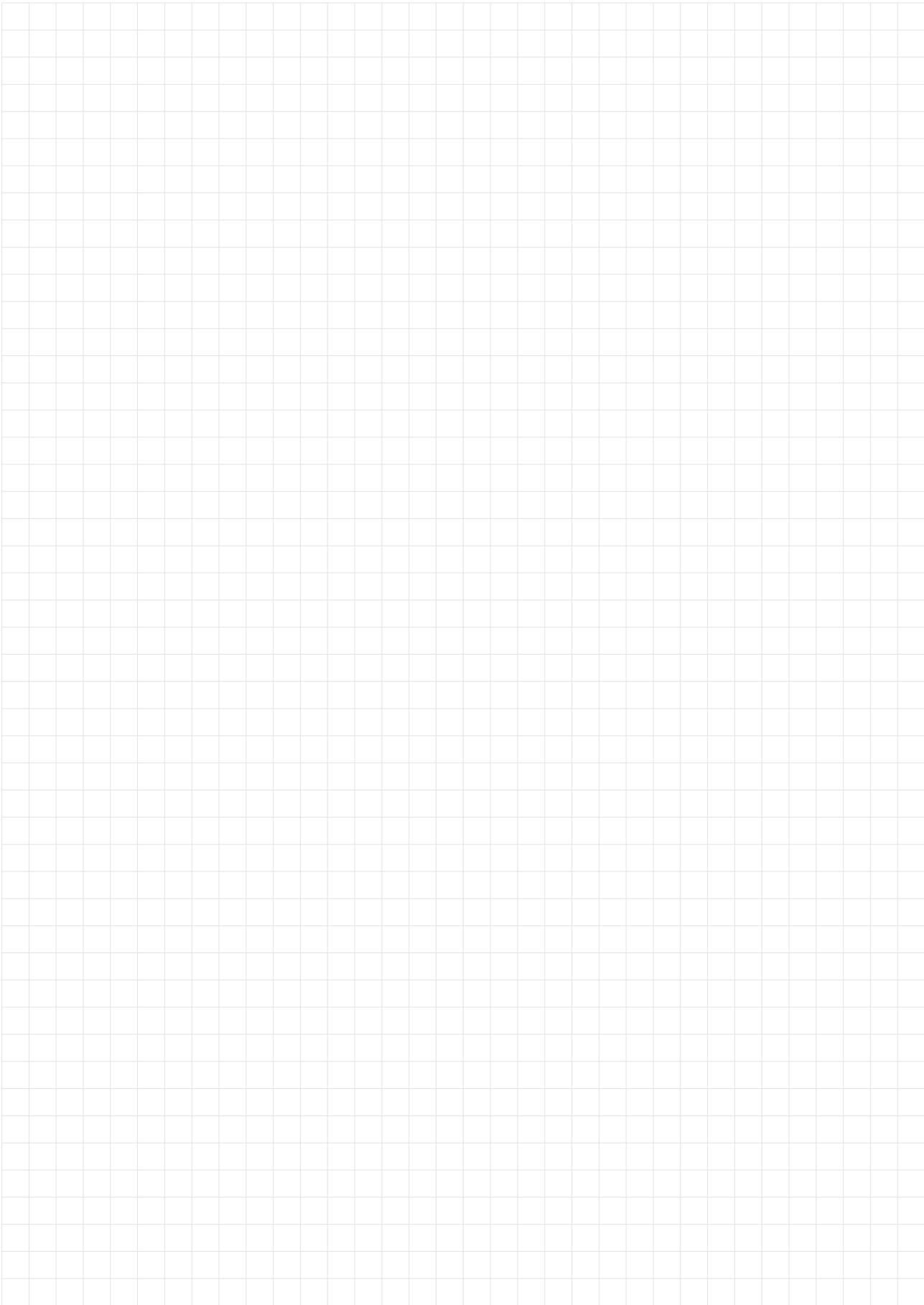

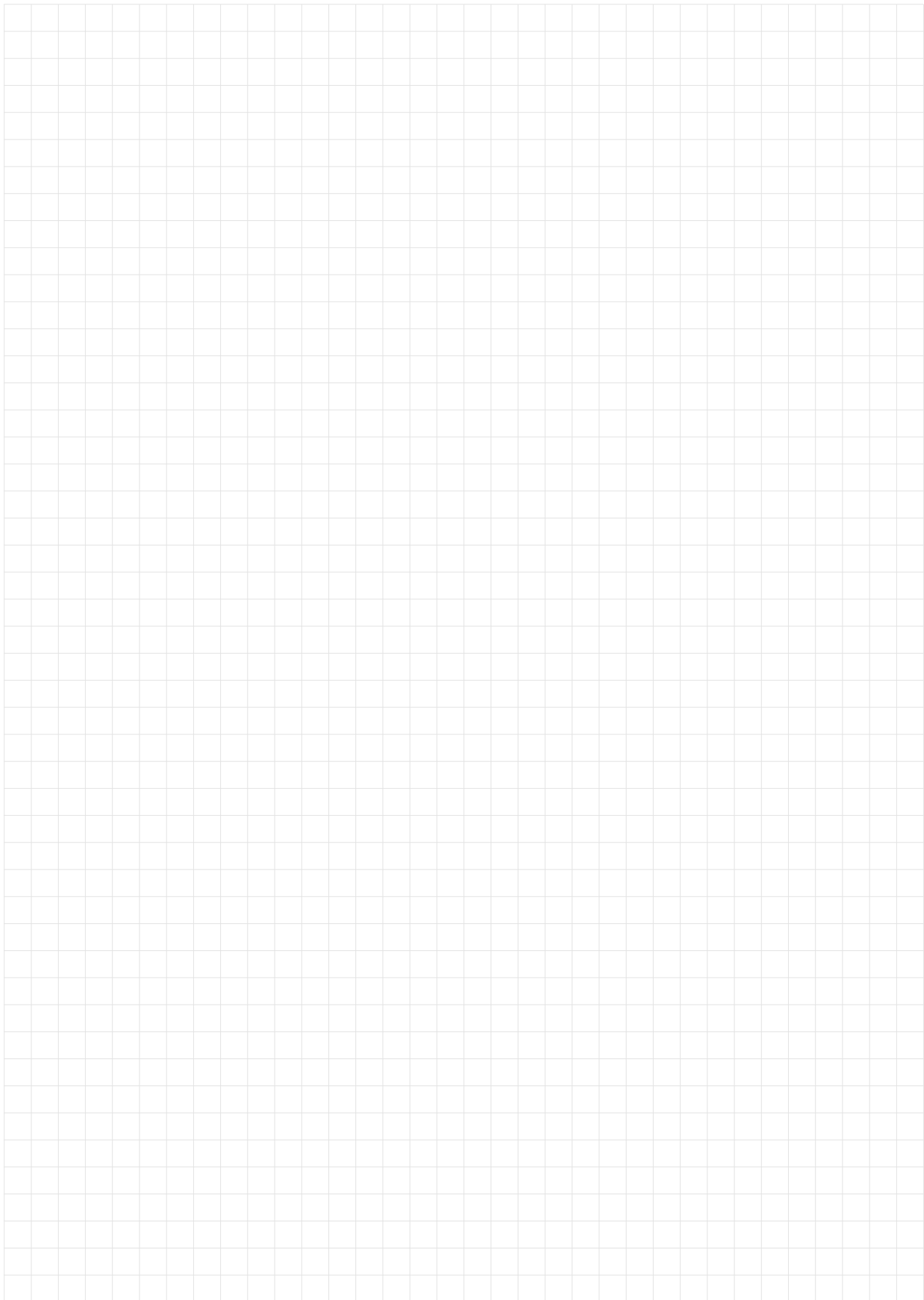

# Catalogue

## General information

The tools shown in this catalogue, the information regarding delivery, appearance, performance and dimensions shall comply with the according status at the time of printing. We develop our products continuously. We reserve the right to change without prior notice. All errors and misprints reserved.

Reprinting as well as any kind of reproduction – even partially – is not permitted without the written permission of TYROLIT CONSTRUCTION PRODUCTS GmbH, 6130 Schwaz/Austria.

A detailed version of our terms and conditions can be found at

[www.tyrolit.com](http://www.tyrolit.com)



**TYROLIT CONSTRUCTION PRODUCTS GmbH**

Swarovskistraße 33 | 6130 Schwaz | Austria

Tel +43 5242 606-0 | Fax +43 5242 63398

Our **worldwide subsidiary** companies can be found  
on our website at [www.tyrolit.com](http://www.tyrolit.com)



Find us on social media  
**TYROLITgroup**